



USER MANUAL FOR SPA

/ CONTROL SYSTEMS / KEYPADS / ACCESSORIES /

TABLE OF CONTENTS

Introduction	2
Safety instructions	3
Controls	5
Initial installation	6
User interface	
Easy 4	8
Easy 7	11
Smart Touch	25
Using the turbine	48
4 and 1 single button panel	49
Optional accessories	
Aquasoul Pro	50
My Music	54
UV-C	55
Ozone	56
in.grid	57
in.touch 2	60
Chemical treatment	86
Sand filter system	89
Water treatment basics	90
Maintenance	91
Wiring diagram	
W2000	92
W3000 & W5000	95
W8000	99
Breaker setting	102
Frequently asked questions	104

INTRODUCTION

Congratulations on your new product!

Outside work and family the enjoyment of quality life and calm moments plays an important role in the life of a 21st century man. An evening bath in the spa or tub alone or in company can give you the opportunity to lose track of time and your body and soul can relax. From the world of rationality we get into the world of senses where the cossetting atmosphere of the water provides the perfect conditions for relaxation.

Our design engineers utilised the experiences of the ancient Eastern massage culture and the modern findings of Western hydrotherapy to create spas providing the perfect massage experience.

Develop a peaceful space for relaxation with your product in your home and join the group of the few who seek a positive impact on their environment by establishing internal harmony.

Dive into your spa and enjoy the gently flowing water!

Aeware®, Gecko®, and their respective logos are Registered Trademarks of Gecko Alliance Group. in.yt™, in.ye™, in.yj™, in.touch™, in.stream 2™, DJS™, in.k110™, in.k120™, in.k361™, in.k1001™, in.clear™, and their respective logos are Trademarks of Gecko Alliance Group.

All other product or company names that may be mentioned in this publication are tradenames, trademarks or registered trademarks of their respective owners.

SAFETY INSTRUCTIONS

FOR YOUR SAFETY PLEASE ALWAYS PERFORM THE FOLLOWING PRECAUTIONS. IF YOU DO NOT FOLLOW THE WARNINGS AND INSTRUCTIONS, ITEMS MAY GET DAMAGED, YOU MAY GET INJURED, OR YOU MAY SUFFER FATAL INJURY. IMPROPER INSTALLATION AND OPERATION INVALIDATES THE WARRANTY.

Initial safety warnings

The spa must be powered through a residual current device (RCD) with a current release not exceeding 30mA.

The devices and parts which contain active parts – except those which are powered from protective extralow voltage not exceeding 12V – must be inaccessible from the spa.

ABOUT THE ENVIROMENTALLY SAFE WATER DRAINING

The spa must be powered through a residual current device (RCD) with a current release not exceeding 30mA.

The devices and parts which contain active parts – except those which are powered from protective extralow voltage not exceeding 12V – must be inaccessible from the spa.

About the enviromentally safe water draining

The water temperature in the spa should never exceed 40°C (104°F). The water temperature is considered safe for a healthy adult at 36 to 38°C. Lower water temperature is recommended for younger children or when the spa is used for more than 10 minutes.

Spa heat can cause hyperthermia!

Symptoms: drowsiness, heaviness

Children under 14 years of age can only use and operate the products mounted with hydromassage system under adult supervision.

People with heart disease, low or high blood pressure, circulatory disorders, diabetes, and excessive weight should consult their physician prior to using the spa.

Consumption of alcohol or drugs while using the spa greatly increases the chance of fatal overheating.

A person taking medications should consult a doctor before using the spa as some medicines may cause drowsiness while others may affect the heart rate, blood pressure, and circulation.

Persons who suffer from infectious diseases should not use the spa.

Because high water temperature poses a high risk to the fetus and may cause serious fetal damage we advise that (potentially) pregnant women do not use the spa at a water temperature higher than 38°C. Wet surfaces can be slippery. Note and warn your child about this when entering and leaving the spa. To avoid injury carefully get into and out of the spa.

Do not use the spa if the suction cover is damaged or missing.

Never place any electric device within a 2-meter radius of the spa - it can cause electrical shock. Electric devices fallen into water may cause death, electric shock, or serious personal injuries.

It is prohibited to remove the panels while using the spa.

Water treatment should be carried out with caution. Improperly chemically treated* water may cause skin irritation.

When the spa is not in use, cover the spa with the cover to prevent ultraviolet radiation causing damage to the product.

Do not allow your child to climb on the thermo cover when it is on the water-filled spa.

Do not remove any suction sealing. Do not operate the spa if the suction sealing is broken or missing.



WARNING! *The metallic parts of the pool may become hot when exposed to sunlight and can cause injury!*

Keep your clothes and jewellery away from rotating jets and moving parts.

Test the residual current device before use.

Disconnect the spa from the power supply before servicing its electrical parts. (This operation can only be performed by qualified professionals).

It is strictly prohibited to use the spa in a not completely assembled state (e.g. detached side panel)

Chemical treatment of water can only be performed by persons under the age of 18 under parental supervision.

Maintenance can only be performed by trained professionals.

The user should check the electrical wiring every 3 months. It is required to perform a check by a professional every 3 years.

Mains fuses / circuit breakers may be activated because of power outages.

Installation and wiring of the spa, replacement of power cord, and any repairs must be performed by qualified professionals.

It is required to build in an isolating device to the fixed wiring.

Plug'n'play safety warnings

Beyond the previous warnings, please also pay attention to the undermentioned ones.

ATTENTION! *The electrical receptacle must be located at least 2.5 meters from the spa so that bathers in a sitting position cannot reach it from the water. The plug can only be connected to a receptacle* equipped with 2.5mm 2 diameter cables*

ATTENTION! *RISK OF ELECTRIC SHOCK. The connector with residual current device must be inspected before every use.*

ATTENTION! *Only place the RCD plug in a receptacle equipped with RCD.*

ATTENTION! *Before you insert the plug into the socket ensure that the current of the socket and the fixed wiring is appropriate for the properties of the spa.*

The spa must be equipped with an isolation transformer or powered through a residual current device with a release current not exceeding 30mA.

THIS PRODUCT IS EQUIPPED WITH A GROUND FAULT CIRCUIT BREAKER (GFCI) IN THE CONNECTOR. GFCI MUST BE TESTED BEFORE EACH USE.

If the power cable is damaged, it must immediately be replaced by the manufacturer or a service professional in order to minimize danger.

To minimize the risk of electric shock do not use extension leads to connect the product to the power supply.

Ensure that the receptacle is properly located.

Parts of the equipment cannot be placed above the spa during usage.

SAFETY INSTRUCTIONS

Parts under electrical power – except those operating with voltage not exceeding 12V - must be inaccessible for persons in the spa. The grounded device must be connected to a fixed socket with fixed wiring. Electrical parts – except remote controllers – must be positioned so as not to fall into the spa.

The electrical installation must meet the local standard requirements.

To avoid electric shock do not use the spa in rain.

Water attracts children. Always place and lock the cover on the spa after each usage.

Do not bury cables into the ground! Place the cables so that lawnmowers, trimmers, and similar devices will not reach them.

Do not force push the control panel up nor down and do not place heavy objects on it after installation.

Keep pets away from the spa to avoid damage.

Do not use the device if there is the slightest chance of water in the spa being frozen.

Only use accessories approved by us. The use of accessories not approved by us may void the warranty.

Choking hazard. Particular attention need to be paid to children during usage. To avoid accidents only allow children to use this spa under adult supervision.

Never operate electrical devices in the spa or with wet body. Do not place electrical devices (lamp, radio, television) within a 1.5m radius of the spa.

Do not expose the spa to direct sunlight.

Only connect the spa to an earthed socket.

Risk of electric shock. Install the unit at least 1.5m (5 feet) from any metal surfaces. You can install the unit 1.5m from metal surfaces only if every metal surface is permanently connected to a solid copper conductor

with a diameter of at least 6mm, which is connected to the cable connector of a junction box reserved for that purpose.

To avoid injury never pour water warmer than 40°C directly into the spa.

Effects of overheating: you cannot assess emergency situations, do not feel the temperature, do not feel the need to get out of the spa, cannot get out of the spa; risk of fetal damage in pregnant women, loss of consciousness, suffocation.

Do not use the spa alone.

Do not use the spa immediately after strenuous sport.

To prevent damage to the pump the spa can only be operated if it has been filled with water.

If you feel uncomfortably or sleepy, leave the spa immediately.

Never add water to the chemicals. Always be cautious when adding chemicals to the spa water to avoid inhaling vapors and possible effects of inhaling undiluted chemicals and splatters.

Only place the spa on a surface that can support its weight.

INSPECT THE UNIT BEFORE USE. CONTACT THE SERVICE PROVIDER STATED IN THIS MANUAL IF ANY OF THE PARTS WERE DAMAGED OR MISSING UPON PURCHASE. ENSURE THAT THE PARTS OF THE UNIT ARE THOSE WHICH YOU INTENDED TO BUY.

IN.CLEAR SAFETY WARNINGS

Beyond the previous warnings, please also pay attention to the undermentioned ones

Read this manual carefully, always follow its instructions, and retain it. This manual contains important information about the installation, operation, and safety recommendations of the in.clear unit. Safe installation and usage is your responsibility.

The in.clear unit must be connected to a network protected by a ground fault circuit interrupter (GFCI) of the maximal nominal fault current value of 30mA.

Ensure that the entire power supply is turned off before the in.clear unit is installed.

If the power cord is damaged, it must be replaced by the manufacturer, an authorized service provider, or qualified professionals to avoid emergencies.

Always use a proper electric cable for supply of current to the in.clear unit.

When installing the in.clear Automatic Bromine Generator local and international electrical regulations must be complied with.

Clean or replace the filter cartridge at regular intervals, otherwise part of the bromine produced by the in.clear unit will be consumed by oxidation of contamination accumulated in the filter.

DO NOT pour any other chemicals into the spa than the recommended sodium bromide. DO NOT use any ozone or UV disinfectant.

Operating the in.clear unit on lower sodium bromide level shortens the life of the cells. Keeping sodium bromide and bromine levels above the recommended level may lead to corrosion of the spa components and cause damage to the spa accessories.

Do not open the in.clear unit; it does not contain serviceable parts

Product disposal: the in.clear unit must be disposed of in accordance with local disposal regulations in force.

This device is not intended for use by persons (nor children) with limited physical, sensory, or mental capabilities except if these persons have received appropriate instruction on use of the device from the person responsible for their safety.

The in.clear unit cannot be applied to in-ground sunken spas as it may affect materials used in the construction.

The shut-off device must have fixed wiring in accordance with the cable regulations.

Showering is compulsory before each spa use.

The user is responsible for regular monitoring of the spa water to ensure that enough bromine is available to reach the appropriate cleaning level. Intensive spa use may require higher bromine intake to always maintain appropriate bromine level.

Always check the expiry date of the test kit, because after this date the test results may be inaccurate.

For proper disinfection spas must periodically be completely drained. The advised time period between full drains given in days is calculated by dividing the capacity of the spa in litres by the tenfold of the average daily users.

The in.clear unit is applicable for indoor spas, but NOT for swimming pools.

CONTROLS

ENRICHMENT:

With the enrichment tool additional air is introduced to the jets, which strengthens the effect of the massage. Open to the right, close to the left.



WATER FLOW REVERSER

With water reversing you share the jets in each seat. If you turn the water reverser to the right, it will operate the jets on its right seats. if you turn it to the left, it will operate the jets on its left seats. In center position all the jets controlled by water reversing will operate. In this case the efficiency of the massage is reduced (it splits among the seats).



TAP

The tap has an opened and a closed position. When it's open, it can operate the waterfall nozzle, the one-hole fountain, or the neck massage unit. The tap opens to the left, (3, 2/3 rewind) and closes to the right (3, 2/3 rewind).

INITIAL INSTALLATION

SITE PREPARATION

When choosing a site for the spa take into account that its maintenance and repair works must be carried out behind the sidewalls, so accessibility and space to walk around the spa must be ensured.

1. INDOOR/BASEMENT INSTALLATION

If you place your spa indoors, be aware of some special requirements:

Water may accumulate around the spa, so the flooring material must have a proper runoff to avoid accumulation of water. When building a new room for the spa, constructing a floor drain is required, or damages may occur due to overflow, overfilling, or technical failure. Our company does not take responsibility for any damage in absence of floor drainage. Humidity will naturally increase in the room where the spa is located and the evaporated water condenses. For this reason ensure that the area has proper ventilation. We recommend installing a dehumidifier in the room.

2. OUTDOOR AND PATIO INSTALLATION

A solid horizontal foundation is necessary for installation of the spa. We advise using a reinforced concrete foundation at least 10-15cm thick.

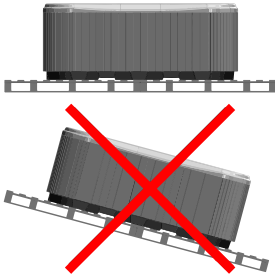

Ensure that your deck or foundation will support your spa. You must know the maximal load capacity of the foundation. Consult a qualified building contractor or structural engineer.

To find out the weight of your spa, its contents and occupants please refer to the spa specification chart. This weight must not exceed the structure's rated capacity per square meter, otherwise serious structural damages could result. If you install the spa outdoors, we recommend a reinforced horizontal concrete pad at least 10-15cm thick.

Install floor drains around your spa to lead water away even in heavy rain.

When constructing the water drain it is advised to form a 10-15cm deep sloping ditch around the spa which directs water to the drain. Water from the drain must be directed to the canal or a drainage with enough capacity.

Warning: Do not expose the spa to direct sunlight (not even empty) without proper coverage. The insulated spa cover preserves the water temperature and provides protection from sunlight and rain. When exposed to sunshine for a longer period it may damage the surface of the spa and the spa equipment.

Acrylic rapidly absorbs heat from sun rays, thus reaches a very high surface temperature which may damage the spa.

In case of sealed design, if the spa was placed between glass structures, prevent the sun rays from reaching the spa directly through the glass as the temperature may get too high.

3. IN-GROUND / SUNKEN SPA

In case of sinking the spa into the ground you must make sufficient space for walking around the spa. For completion of maintenance works a minimum of 60cm wide inspection pit must be built around the spa.

The inspection pit's bottom must be under the bearing point of the spa so that water can flow into the pit in case of water leakage. A floor drain or sump pump should be used at the bottom of the pit to ensure continual water drainage.

In case of sinking the spa only the portion below the spa's acrylic edge can be sunk. The air of the inspection pit steams up. To prevent unpleasant odors proper ventilation must be provided (e.g. installing ventilators). The costs of pulling the spa out of the ground are borne by the user. If the aforementioned conditions are not present, setting up the spa may fail.

First filling of the spa

Proper filling of the spa is an important task both technically and chemically. We advise installation and periodic maintenance by the servicing professionals, which includes inspection and refilling of spa water. Spas do not contain water softener and hard water damages the equipment. Improper filling of the spa may bring air into the system, which damages the heating wire and engines. Pure stream WE00067 (water softener) and Pure fill WE00068 (carbon filter) are ensured for your spa. Please fill your spa exclusively through this filters. Repairs after such failures are not covered by warranty.

Filling process

Remove the spa cover. First remove the cover staves, then remove the side covers by unscrewing the bottom screws. During transportation the flare fittings of engines may dislocate. Check these connections before installation. If necessary, tighten the flare fittings.

In spas equipped with air engine the flare fitting must be connected before running the spa for the first time.

Before filling the spa check that the ratchets are not in a closed state (lever is pulled out and fixed with the safety lock).

Next fill the spa with water to the sign indicated on its sidewall.

Filling must be done through the filter housing. Improper filling can damage the engines and heating element.

Insert the filter or filter cartridges when proper water level is reached. Be cautious, because when replacing the filter cartridge air bubbles may remain in the cartridge. To avoid this the filter cartridges must be tilted in the water to remove air from them, and only then fitted to their place.



INITIAL INSTALLATION

IONIC EXCHANGE WATER SOFTENER AND CARBON FILTER

For the optimal quality the following steps shall be followed during the usage:

1.

Please check the required water volume in the manual of the spa or contact our customer service for help. The exact volume is needed for the precise filling.

2.

Please remove the covering caps from both ends to connect the filling hose.



3.

Please connect the carbon filter to the water hose via the screw thread gadget (included with the filter).

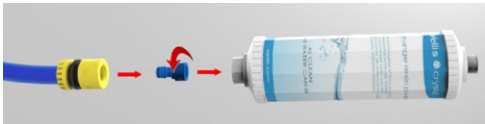

4.

Please run water through the filter into a separate vessel until it becomes perfectly clear. This step allows the filter to rinse from the remaining carbon powder. The rinse cycle lasts for 30 seconds at most with approx 10 litres of water.



0'-30'



>30'

5.

Through the clean filter fill up the spa with one third (1/3) of the total volume (e.g.: with 1000 litres of total volume 1/3 is 300 litres). It is important to follow the instructions of the filling for it is crucial to set the precise water hardness.

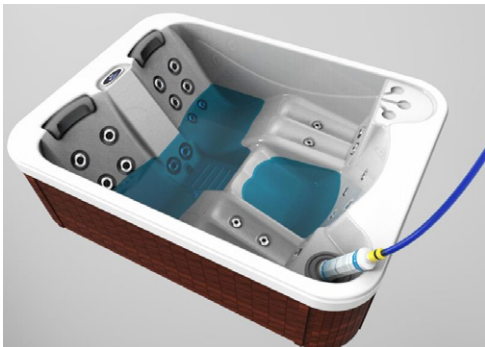

Insert the filter or filter cartridges when proper water level is reached. Be cautious, because when replacing the filter cartridge air bubbles may remain in the cartridge. To avoid this the filter cartridges must be tilted in the water to remove air from them, and only then fitted to their place.

6.

After the filling please remove the caps from the water softener cartridge too and connect it with the carbon filter. With water softener the rinsing is significantly faster, so only this first 1 liter needs to be drained separately!

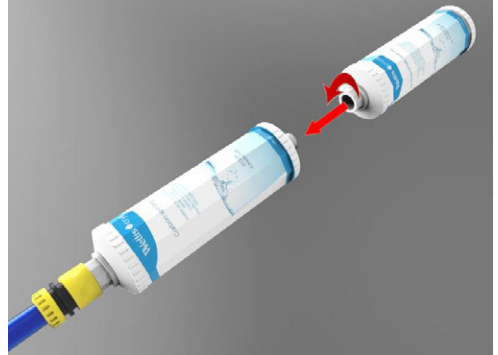

7.

Please check the water hardness during the filling with the softener. There are multiple choice of using a hardness tester. Testers sold by Wellis are showing the hardness level on a colour scale.

If the value shown is less than the optimal value the water will create foam during the usage, if the value is more that will cause limescaling.



8.

If the water hardness is extremely low during the filling please remove the softener cartridge and continue the filling with only the carbon filter as it shown at point 5.

USER INTERFACE - EASY 4

EASY 4

COMPACT FULL-FUNCTION KEYPAD

The Quick Reference Card provides an overview of your spa's main functions and the operations accessible from your digital keypad. This QRC depicts a generic overlay, custom versions may vary.

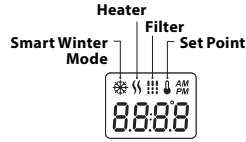

1 PUMP MODEL

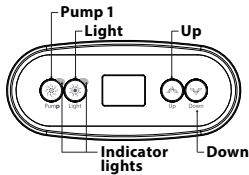

2 PUMP MODEL

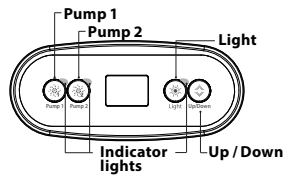

SPA FUNCTIONS



OFF MODE

Pressing Pump 1 for 5 seconds will enable the Off mode. This mode allows you to stop all outputs including automatic functions such as filter cycle, heat request and smart winter mode for 30 minutes to perform quick spa maintenance. When Off mode is active, the display will toggle between the "OFF" message, the clock and the water temperature.

The spa light will flash for a few seconds before the end of the 30 minutes to warn you that the system is about to resume its normal operation. Press Pump 1 or Pump 2 (if available) to restart the system before the expiration of the 30 minute delay. When the system resumes its normal operation, the display shows "On" for 3 seconds.

PUMP 1

Press Pump 1 key to turn Pump 1 on at low speed. Press a second time to turn pump to high speed (with a dual-speed pump*). A third time turns pump off. A built-in timer automatically turns pump off after 20 minutes, unless pump has been manually deactivated first.

The "Pump 1" indicator lights up when Pump 1 is on. With a dual-speed pump, the indicator will flash when pump 1 is on at low speed.



PUMP 2 KEY

Not available on all models
Press Pump 2 key to turn Pump 2 on at low speed. Press a second time to turn pump to high speed (with a dual-speed pump*). A third time turns pump off. A built-in timer automatically turns pump off after 20 minutes, unless pump has been manually deactivated first.

The "Pump 2" indicator lights up when Pump 2 is on. With a dual-speed pump, the indicator will flash when pump 2 is on at low speed.



LIGHT KEY

Press Light key to turn light on. A second press turns light off. A built-in timer automatically turns light off after 2 hours, unless it has been manually deactivated first.

The "Light" indicator lights up when light is on.



UP/DOWN KEYS

Use Up or Down key to set desired water temperature. The temperature setting will be displayed for 2 seconds to confirm your new selection.

2 pump spas have a combined Up/Down key. Hold the button to increase the parameter and release the button to stop. Hold the button again to decrease the parameter.

The "Set Point" icon indicates that the display shows the desired temperature, NOT the current water temperature!

*If single speed pump: press Pump key to turn pump on. Press Pump key again to turn pump off.

USER INTERFACE - EASY 4

PROGRAMMING STEPS



PROGRAM MENU



The program menu is accessible by holding down the Light key for 5 seconds. In the program menu the following parameters can be set: clock, the filter or purge cycles, economy mode and temperature units. While you are in the program menu, use the Up or Down key to adjust the parameters and use the Light key to jump to the next parameter.

The changes will be saved after the confirmation of the last parameter only. If there is no action taken for 10 seconds, the system will exit the program menu without saving any changes.

SETTING THE CLOCK

Enter the program menu by holding down the Light key for 5 seconds. The display will show the current clock setting with the hour flashing.

Depending on factory settings your system may be set to 24-hour time or 12-hour time.

Setting the hour: Use the Up or Down keys to adjust the hours. Press the Light key to jump to the next parameter, the minutes.

Setting the minutes: Use the Up or Down keys to adjust the minutes. Press the Light key to jump to the next parameter, the filter or purge start time (FS).

PROGRAMMING THE FILTER/PURGE CYCLES

Depending on system configuration your spa will perform either a filter or a purge cycle. The filter cycle menu consists of the following parameters: the start time (FS), the duration (Fd) and the frequency (FF). The purge cycle menu consists of the following parameters: the start time (FS) and the frequency (FF).

A filter cycle consists of starting all the pumps and blower in high speed for 1 minute (purge step) then, the pump associated with the filter will run in low speed for the remaining duration of the filter cycle (clean step).

A purge cycle is used when the spa is equipped with a 24 hour circulation pump which provides a continuous clean step. It consists of starting all the pumps and blower in high speed for 1 minute.

SETTING FILTER OR PURGE CYCLE START TIME

The display will show FSxx, "xx" representing the starting hour of the cycle. Use the Up or Down key to adjust the hours. Use the Light key to jump to the next parameter, filter duration (Fd).



SETTING FILTER CYCLE DURATION

(not available on purge systems)

The display will show Fdxx, "xx" representing the duration in hours of the filter cycle. Use the Up or Down key to adjust the duration. Use the Light key to jump to the next parameter, filter or purge frequency (FF).

0 = no filtration

24 = continuous filtration

It is not recommended to set this to "0".

SETTING FILTER OR PURGE CYCLE FREQUENCY

The display will show FFxx, "xx" representing the number of cycles per day. Use the Up or Down key to adjust the frequency. Use the Light key to jump to the next parameter, economy mode (EP).

The "Filter cycle" indicator lights up when filter is on and flashes when suspended.

SETTING ECONOMY MODE

This mode allows you to lower the temperature set point of the spa by 20 °F (11 °C) during a certain period of the day.

The display will show EPx, "x" representing the state of the programmed economy (0 = disabled, 1 = enabled). Use the arrow keys to enable or disable economy mode. Use the Light key to jump to the next parameter, economy start time (ES).

SETTING ECONOMY START TIME

The display will show ESxx, "xx" representing the hour at which the economy mode will become active. Use the Up or Down key to adjust the hour. Use the Light key to jump to the next parameter, economy duration (Ed).

When the Economy mode is ON, the display will toggle between the "Eco" message, the time, and the water temperature.

SETTING ECONOMY DURATION

The display will show Edxx, "xx" representing the duration in hour of the economy mode. Use the Up or Down key to adjust the hour. Use the Light key to jump to the next parameter, temperature unit.

24 = continuous economy

Note that the parameters for the economy mode settings are associated to specific low level configuration of the system that are not present in all software revisions.

USER INTERFACE - EASY 4



SETTING TEMPERATURE UNIT

Water temperature can be displayed in either Fahrenheit (°F) or Celsius (°C). The display will show F or C.

Use the Up or Down key to change the setting. Use the Light key to save all the parameters.

SMART WINTER MODE

Our Smart Winter Mode protects your system from the cold by turning pumps on several times a day to prevent water from freezing in pipes.

The "SWM" indicator lights up when freezing is detected and flashes when the purge is active.

COOLDOWN

After heating the spa water to the desired Set Point, the heater is turned off, but its associated pump (Pump 1 low-speed or CP) remains on for a predetermined period of time to ensure adequate cooling of the heating element, prolonging its useful life.

WATER TEMPERATURE REGULATION

Every 15 to 90 minutes the pump will run to ensure accurate water temperature readings as well as avoid heater activation in dry conditions. After verifying pump activation and taking a water temperature reading if required, the system

automatically turns the heater on to reach and maintain water temperature at Set Point.

 Indicator flashes when taking water temperature reading.

TROUBLESHOOTING SECTION

Should an error occur, the display will show one of the following error messages toggled with the clock and the water temperature.

IN.XE ERROR CODES

DESCRIPTION



Hr

An internal hardware error has been detected in the in.xe.
Contact dealer or service supplier.



HL

The system has shut the heater down because the temperature at the heater has reached 119°F (48°C).

Do not enter the water! Remove the spa cover and allow the water to cool down, then shut power off and power your spa up again to reset the system.



AOH

Temperature inside the spa skirt is too high, causing the internal temperature in the in.xe to increase above normal limits. Open skirt and wait until error clears.



FLO

The system does not detect any water flow while the primary pump is running.

Check and open water valves. Check for water level.
Clean filter. If the problem persists, call your dealer or service supplier.



Prr

A problem is detected with the temperature probe.

Call your dealer or service supplier.



OH

The water temperature in the spa has reached 108°F (42°C).

Do not enter the water! Remove the spa cover and allow the water to cool down to a lower temperature.

Call your dealer or service supplier if problem persists.

USER INTERFACE - EASY 7

EASY 7

KEYPAD LAYOUT

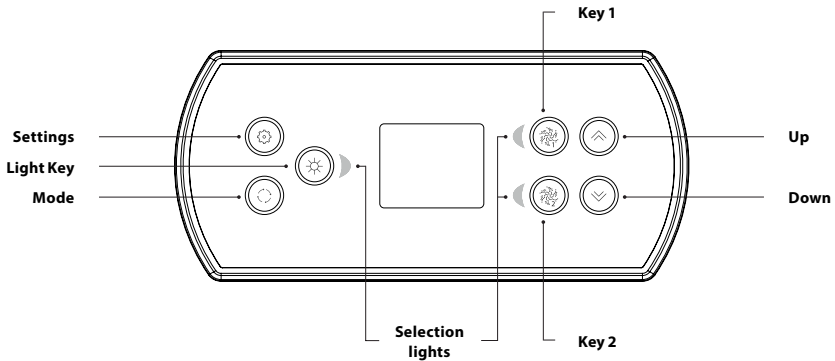

**Functions for keys 1 and 2 will depend on your system's low level configuration.*

SETTINGS KEY

One press gives you access to a menu to manage the settings of your spa. Refer to the settings section for details about the settings menu.

MODE KEY

Successive presses on the Mode key will give access to control different optional accessories of your spa such as Audio and others. Note that if an accessory is not present in your spa configuration, its menu will not appear. Refer to the following section to get details about the possible accessories and their detailed functionalities. The screen will revert back to the spa mode if no key is pressed for 60 seconds.

If you don't have any accessories on your spa, the Mode key can be used to directly change your display orientation.

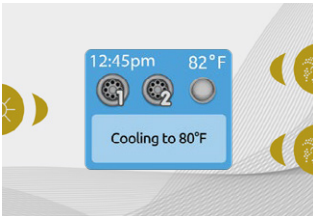

POWER

Press any button to turn the keypad on. After 30 minutes without activity it will shut off.

MAIN SCREEN

The main screen gives you access to your accessories and water temperature. At the bottom of the screen you will see any error or maintenance messages that are present..

USER INTERFACE - EASY 7

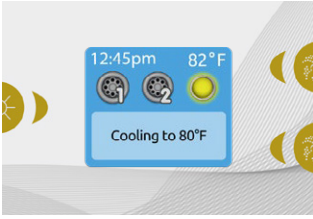

START OR STOP ACCESSORIES

To start or stop an accessory, press the associated button. Icons will become animated when their accessory is turned on, and inanimate when turned off. Icons on the screen will reflect the speed or state of the devices running on your spa. When an accessory has more than two states, press the button until it reaches the desired state.

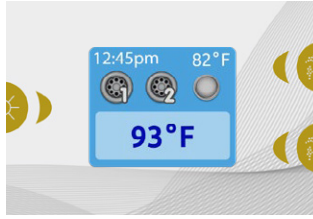

WATER TEMPERATURE

The temperature shown at the top of the screen is the current water temperature. Use the Up and Down buttons to set the desired temperature. The set point will appear in blue at the bottom. After 3 seconds without any change to the set temperature value, the keypad will resume the normal display of messages. When the set value is lower than the current temperature Cooling to xx.x will appear. When the set value is higher than

the current temperature, Heating to xx.x will be indicated. Normally there is a short delay before the heating starts, during which Heating Suspended is indicated.

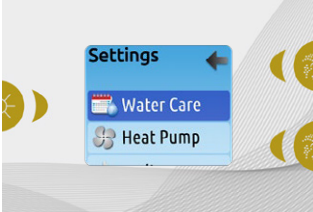

SETTINGS

From the home page you can access the Settings, where you will find:

- Water care
- Heat Pump (if installed)
- Audio (if installed)
- in.clear-200 (linked version)
- Standby
- Maintenance
- Date & time
- Keypad
- Wi-Fi
- Config
- Restore
- About

Use the arrow keys to move up and down in the list. To select an option, press the lit button beside it (Light button).

At any point you can press the Settings button to return to the home screen.

USER INTERFACE - EASY 7

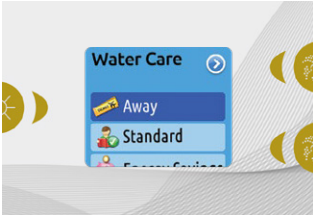

WATER CARE

The Water Care section will help you set up your ideal filtration and heating settings. Choose from Away, Standard, Energy Savings, Super Energy Savings, and Weekender, depending on your need. Use Light key to choose your setting. A checkmark will appear on the selected icon to confirm.

In Economy mode, the set point will be reduced by 20°F*, which means that the heating system will not be engaged unless the temperature falls to 20°F below the spa's set temperature.

** Default pack value*

WATER CARE MODES



AWAY:

In this mode the spa will always be in economy; the set point will be reduced by 20° F*.



STANDARD:

The spa will never be in economy mode and will be filtering according to the pack's low level configuration.



ENERGY SAVINGS

The spa will be in economy mode during the peak hours of the day and resume normal mode on the weekend*.



SUPER ENERGY SAVINGS:

The spa will always be in economy mode during peak hours, every day of the week*.



WEEKENDER:

The spa will be in economy mode from Monday to Friday, and will run normally on the weekend*.

** Filtration will be reduced when the economy mode is active.*

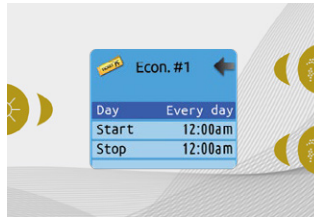
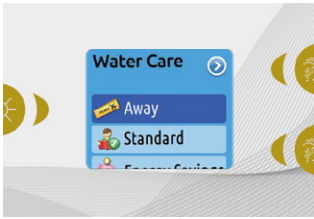

MODIFYING SCHEDULES

To see and/or modify a Water Care category, use the lit button to the right (Key 1) to open the selected Water Care menu.

Use the arrow keys to choose a schedule to modify (choice of economy and filtration schedules). Use the Light key to move between parameters.

You have several possibilities for the schedule (Mon-Fri, weekend, every day, or single days). The schedules will be repeated every week. The time and duration are set in 30 minute increments. Once you have set the schedule, use Key 1 to go back. Ensure that you have selected the desired Water Care option in the main Water Care menu.

The filtration schedule shown on the screen will apply to the main filtration pump, most likely pump 1. If your spa uses a circulation pump configured to run 24 hours, the screen will show you the purge setting instead of filtration. The purges are pre-programmed for a fixed number of minutes, therefore the duration will be set to N/A on the screen, and only the start time can be modified.

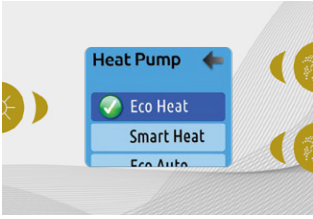

HEAT PUMP

This menu allow you to change the regulation mode of your heat pump. You can choose from Eco Heat, Smart Heat, Eco Auto, Smart Auto, Cool and Electric.

A green checkmark indicates the currently selected regulation mode. To change the setting, simply navigate the menu using the arrow key and press the Light Key to choose the desired regulation mode.

HEAT PUMP MODES



ECO HEAT

In this mode, the heat pump is used as the unique source of heating. The heating element is kept off and the heat pump is not used to cool the water should its temperature rise above the current set point.



SMART AUTO

This mode borrows functionality from both Smart Heat and Cool modes and has the ability to select the proper Heat or Cool mode automatically according to the water temperature. The heating element is activated only if there is a large temperature difference between the water and the set point.



SMART HEAT

This mode uses the heat pump as the main heating source. The heating element is turned on only if there is a large temperature difference between the water and the set point. The heat pump is not used to cool the water in this mode.



COOL

This mode uses the heat pump in cooling mode only. The heat pump is not used as a heating source and the heating element is never activated.



ECO AUTO

This mode borrows functionality from both Eco Heat and Cool modes and has the ability to select the proper Heat or Cool mode automatically according to the water temperature. The heating element is never activated in this mode.



ELECTRIC

This mode keeps the heat pump off and uses only the heating element to regulate water temperature.

USER INTERFACE - EASY 7

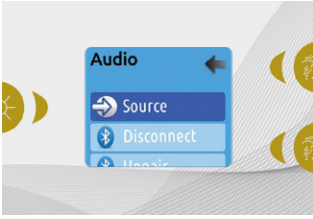

AUDIO

The Easy 7 can be used with the in.tune, in.stream or in.stream 2 audio systems. The Audio section in the Settings menu of an in.stream gives you the option to disconnect or unpair your Bluetooth enabled device when using the in.stream.

With version 7.00 and higher, it is also possible to select Source to use a device connected by auxiliary cable or Bluetooth wireless connection.

The in.stream 2 Settings menu gives you a Source selector, a Bluetooth disconnect option, an On/Off switch and an audio control on fader, balance and subwoofer. For more information on audio functions, see the in.tune, in.stream or in.stream 2 operation section.

The Audio option will only appear in the menu for keypads that are set up for an in.stream connection. The in.stream 2 is automatically detected at power-up.

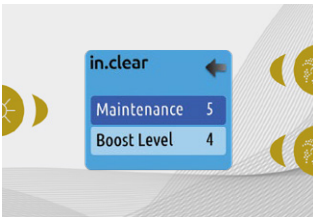

IN.CLEAR-200 / LINKED VERSION

The Easy 7 keypad can be used with the in.clear sanitization system. The in.clear section allows you to configure your maintenance settings and Boost level. For more information on maintenance and Boost settings, see the in.clear user manual.

Use the Up and Down keys to make your selection, then light key to confirm.

Use the Up and Down keys to change the maintenance or Boost value, and light key to confirm.

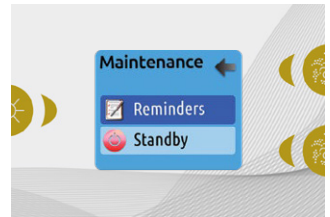

MAINTENANCE

From the Settings page you can access the Maintenance menu, which gives you access to the following options:

- Maintenance reminders
- Standby

Use the Up and Down keys to make a selection, and Light key to confirm.

** If the maintenance value is modified by more than 2, a warning message will appear with an option to cancel or confirm the change.*

USER INTERFACE - EASY 7



MAINTENANCE REMINDERS

The Easy 7 keypad will remind you of maintenance required on your spa, like rinsing or cleaning the filter. Each task has its own duration, based on normal use.

The Maintenance reminders menu allows you to verify the time left before maintenance is required, as well as to reset the time once a task is completed.

Use the Up and Down keys to move through the list.

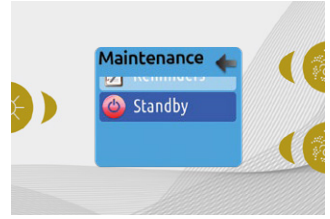

STANDBY

The Standby mode allows you to service your spa. Pumps will stop for 30 minutes, and automatically restart after this time.

Once Standby mode has been activated a screen will appear to show that pumps are stopped. The normal spa page will return at the end of maintenance.

Press the Key 1 to leave Standby mode and restart the spa.

Note: In version 6.00 only, Standby mode is accessible directly from the Settings page.

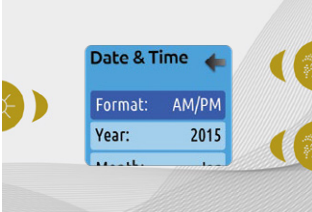

DATE AND TIME

Here you can adjust the time format, change the year, date and time. Use the arrows to choose the setting that you want to adjust, and select it by pressing the Light key.

Use the arrow buttons to change the parameters, and the Light key to move between parameters. Key 1 will take you back to the main Settings menu.

Note: In version 6.00 and earlier, only the day of the week can be changed, and not the year or date.



KEYPAD SETTINGS

In this section, you can change the temperature unit, language, display orientation, rim light color and keypad security. Note the spa pack must be configured accordingly to be able to change the rim light color.

When you change the display orientation, the contextual options and arrow keys adjust to the chosen orientation. If you don't have any accessories installed on your spa, the Mode key can be used as a display orientation key. Simply press on it to change your orientation from normal to inverted, and vice versa.

Whether the display is inverted or not, the Mode and Menu keys remain unchanged, as well as the accessory keys in the main Spa menu.

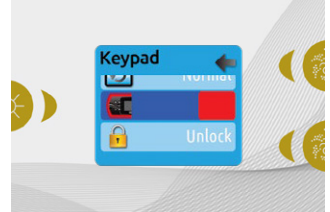

With the Easy 7 equipped with a selectable rim light color modul: If the "RGB backlight" option is enabled in the spa configuration an option will appear to allow selection of the keypad rim light color.

You can lock the keypad by selecting one of 3 security levels: Unlock, Partial or Full. The Partial level locks the set point adjustment and many options in the settings menu. The Full level locks all keypad functions. To unlock the keypad (either Partial or Full), press and hold the top right key for 5 seconds.

USER INTERFACE - EASY 7

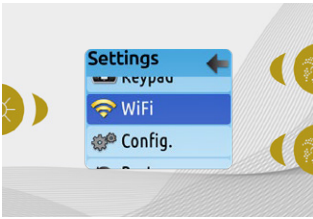

WiFi (IN.TOUCH ONLY)

For the WiFi menu to appear in the Settings menu your in.touch module must be equipped with software version 11.00 or higher. This menu allows you to connect your in.touch module to a WiFi network or to change its network.

For more details about other in.touch connection methods please see the in.touch techbook.

To connect your in.touch module to a wireless network, use the Up/Down keys to go to the WiFi option in the Settings menu and Light key to select it.

After a few seconds the available networks will appear on the screen, as well as their signal strength.

Use the Up/Down keys to move through the list. Select your network by pressing on Light key.

If the WiFi network is password protected enter it when prompted.

- Use the arrow keys to choose your letters and change the type of character (uppercase, lowercase, number, symbol).
- Use Key 2 to move the cursor forward
- Use Key 1 to backspace
- Use Light key to confirm

If no password is required the in.touch will connect automatically.

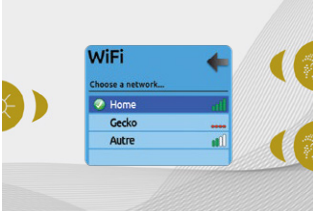

Once the in.touch module is connected to a WiFi network a check mark in a green circle will appear in the WiFi menu, and the network logo will change to green in Settings menu.

Note:

WiFi logo color in Settings menu corresponds to the in.touch connection state.

Yellow = not connected

Green = connected to a network

Yellow with wait icon = connection attempt to a network

Red with wait icon = in.touch no longer detected

(in.touch must be reset before next connection attempt)

USER INTERFACE - EASY 7

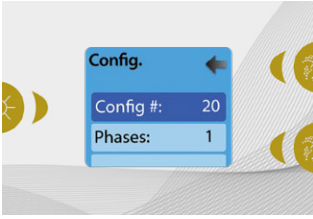

CONFIG

Please do not make changes in the electrical configuration section unless you are a qualified electrician.

In this section you can change the low-level configuration, number of phases, input current and heat pump current.

Use Up/Down to move between parameters, and the Light key to select a parameter to change. Please refer to the techBook of your specific control system for spa for details about the low level settings.

Once you have changed the Number of Phases in the menu, you will be unable to use the Up/Down keys to return to the Low-level Configuration menu. Please go back and re-enter the Config menu.

Note with version 15.00 and higher: Depending on the pack configuration, a code may be required to change these settings. This code is "5555".

The table below shows the key assignment based on the accessories selected in your pack's low level configuration. Please refer to the Quick Start Card (QSC) for specifications to identify the low level configuration for your spa.

POSSIBLE KEY MAPPINGS

Low level configuration	Key 1	Key 2	Light
1 pump	Pump 1	–	Light
2 pumps	Pump 1	Pump 2	Light
2 pumps + blower	Pump 1	Pump 2 + Blower	Light
4 pumps*	Pump 1 & Pump 2	Pump 3 + Pump 4	Light
3 pumps + blower*	Pump 1 & Pump 2	Pump 3 + Blower	Light

*Only pump 1 can have a dual speed.

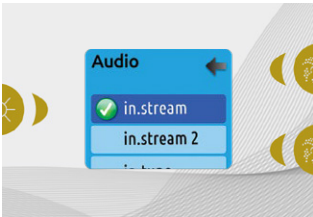

RESTORE/AUDIO CONFIGURATION

When you select Restore you will be asked to confirm your choice. Doing so will reset all settings to factory default.

Following a restore you will be asked to choose your audio source. Use the arrow key to choose between in.stream, in.stream 2, in.tune and no/other audio.

This should only be done at installation or when replacing a part.

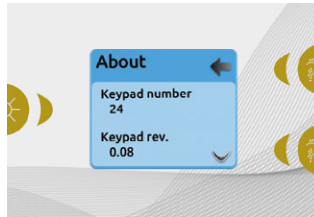

ABOUT

This section shows information about the Easy 7 software number, and the revision numbers of the different components of your system.

IN.STREAM OPERATION

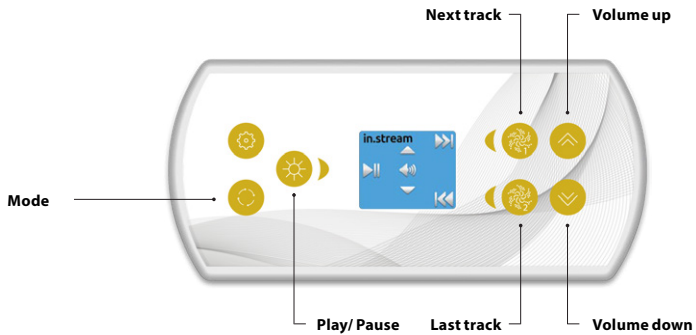

Press the Mode key to access your in.stream.

If you are using a device with Bluetooth technology, it must be connected for functions to work.

Play/Pause audio

Press the Play/Pause button to start or pause the audio.

Adjusting the volume

Press the Up or the Down key to increase or decrease the volume.

Turn power On/Off (version 7.00 and higher)

Press and hold the Play/Pause key for 3 seconds to turn the in.stream on or off.

Changing tracks

Use the Last Track and Next Track keys to change tracks.

Disconnect or Unpair Bluetooth

These options can be found under the Audio section in the Settings menu.

IN.STREAM 2 OPERATION

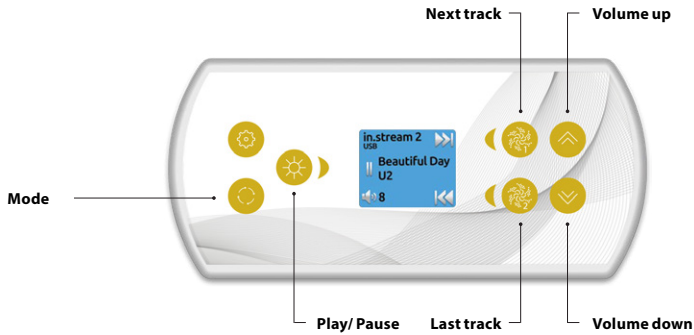

Press the Mode key to access your in.stream 2.

If you are using a device with Bluetooth technology, it must be connected for functions to work.

Play/Pause audio

Press the Play/Pause button to start or pause the audio. This button is available for Bluetooth and USB only.

Adjusting the volume

Press the Up or the Down key to increase or decrease the volume

Turn power On/Off

This option can be found under the Audio section in the Settings menu.

Changing tracks

Use the Last Track and Next Track keys to change tracks or FM stations. This is not available with Aux source.

Disconnect

This option can be found under the Audio section in the Settings menu.

Fader, Balance and Subwoofer

These options can be found under the Audio section in the Settings menu.

IN.CLEAR FUNCTIONS

This menu is only available if an in.clear linked is detected.

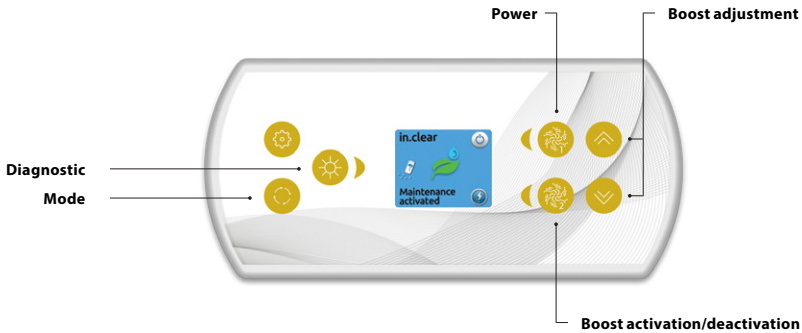

Press on the Mode key to access your in.clear module.

This menu allows you to activate or deactivate your in.clear, to start or stop a Boost, and to enter diagnostic mode.

Turning the in.clear on/off

Press the power key to turn the in.clear on or off.

Control the Boost level

Press on the Boost activation/deactivation key to start a Boost, and again to cancel.

To adjust the Boost level use the arrow keys.*

A message indicating that Boost mode is active is displayed at the bottom of the main screen for the duration of the Boost.

* See the in.clear user manual for more details about Boost levels.

Diagnostic Mode

Press on the Diagnostic key to start a BromiCharge concentration level test. To exit diagnostic mode press on the Diagnostic key again. The system will automatically exit after 15 minutes.

In diagnostic mode, the BromiCharge gauge indicates the approximate level of BromiCharge in the spa water. Do not add BromiCharge if the indicator is in the green zone.

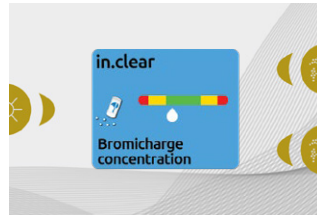

When BromiCharge is added the indicator will move slowly to the right. When water is added to the spa the indicator will move to the left. To obtain a good level of BromiCharge, start the pumps and add the specified amount of BromiCharge** and allow 5 minutes for the indicator to adjust before adding more.

For optimal performance, aim for the middle of the green zone.

** For more information on adjusting your BromiCharge level see the in.clear user manual.

USER INTERFACE - EASY 7

ERROR MESSAGES

The list below shows the different error messages that can appear on the home screen. Refer to the troubleshooting and error codes section of the TechBook for your spa pack system.

Code	Message
HL	Warning! HL Error
FLO - L01 FLO - L02 FLO	FLO condition - Check filter, pump, blockage, air lock and water level
NO FLO	Persistent NO FLO, all off - Check filter, pump, blockage, air lock and water level
HR	Danger! Relay stuck
OH	Warning! Spa temp. high
Pr	Warning! Temp. probes defective
AOH	Internal pack temp. high
FLC	Flow switch closed
SP in	Input voltage issue
RH NC	Comm. error in.xm2 - in.therm
RH ID	in.xm2 - in.therm incompatible
SC ER	Learning mode error
F1	in.xm2 Fuse # 1 is blown
F2	in.xm2 Fuse # 2 is blown
F3	in.xm2 Fuse # 3 is blown
Hr	Danger! Thermal fuse error
UPL	The spa pack does not have valid software. Please insert valid in.stick to reprogram spa pack.
CFLO	No Flow condition (in.clear)
HlBr	Add fresh water to the spa (in.clear)
HiBr	Add fresh water to the spa (in.clear)
LoBr	Add BromiCharge to spa water (in.clear)
NoBr	Add BromiCharge to spa water (in.clear)
Comm	Verify cable connections (in.clear)
Supp	Connect power cord to 240 V source (in.clear)
HP	1-99 Heat Pump error 1-99!

USER INTERFACE - EASY 7

FEATURE MATRIX

The following table presents the features and/or options available for the Easy 7 keypad, and the earliest software version at which this feature/option is available. All versions greater than the earliest version continue to support the feature.

Keypad functions	Earliest support
Power	3.00
Main screen	3.00
Start or stop accessories	3.00
Water temperature	3.00
Settings	3.00
Water care	3.00
Water care modes	3.00
Modifying schedules	3.00
Audio	3.00
in.clear-200 (linked version)	13.00 **
Maintenance	
Maintenance reminders	7.00
Standby	6.00
Date and time	3.00
Keypad settings	
Temperature unit	3.00
Language	
English	3.00
Français	3.00
Español	6.00
Polski	6.00
Nederlands	6.00
Deutsch	6.00
Norsk	6.00
Svenska	6.00
Magyar	10.00
Italiano	10.00
Português	10.00
Česky	14.00
Display	7.00
Color	12.00
Security	15.00
Wi-Fi	7.00*
Electrical configuration	3.00
Factory reset/Audio config.	3.00
in.tune functions	3.00
in.stream functions	3.00
in.stream 2 functions	11.00
in.clear functions	13.00 **
in.mix functions	19.00
Heat pump functions	21.00
White zone 2	3.00
About	3.00

* Only available with the latest software version of the X and Y Series spa systems, and software version 11.00 or higher of the in.touch module.

** Only available with the latest software version of the X and Y Series spa systems.

USER INTERFACE - SMART TOUCH

SMART TOUCH

TOUCH SCREEN KEYPAD

No buttons, keys and overlays! Mode and function selection wheels, all-on or all-off one touch activation key of last used settings, interactive display icons and on-screen messages are all elements of the Smart Touch user interface designed to let spa users interact intuitively with their spa and its value-added accessories.

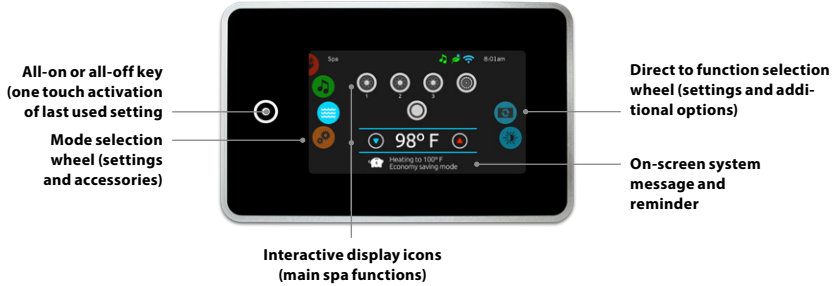

NOTIFICATION ICONS

Notification icons at the top right-hand side of the screen show the status of connected value-added accessories.



SPAS FUNCTIONS

Quick and easy step-by-step instructions to control the main functions and to configure the system settings of your spa from its Smart Touch main spa keypad.



TURN KEYPAD ON

3 minutes after the last pump is turned off, the screen will shut off if there is no touch activity.

Touch the screen to turn on the keypad. Then follow the instructions on the screen to access the main screen.

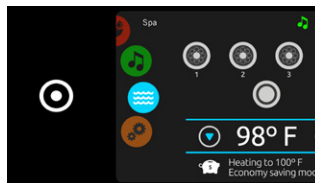

ALL-ON, ALL-OFF TARGET KEY

Smart Touch features an all-on or all-off one touch activation key of last used settings that, when pressed, stops or starts all working components and accessories at once.

From the home page you can access the following modes:

- sanitization (with in.clear connected)
- audio (with Aqasoul Pro connected)
- color (with in.mix installed)
- spa
- settings

To select a mode, slide the left wheel up or down until the desired icon menu is highlighted in the middle.

USER INTERFACE - SMART TOUCH

SPA MODE

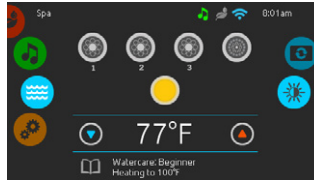

SPA MODE

To select the spa mode, slide the left wheel up or down until the spa icon is highlighted in the middle. The home page will be displayed its equipment start or stop keys, up and down buttons, water temperature, messages and quick access to display options:

- display orientation
- display contrast

To select an option, slide the right wheel up or down until the desired icon menu is highlighted in the middle.

START OR STOP ACCESSORIES

To start or stop an accessory (pump, blower, light), touch the associated icon. Icons will become animated when their accessory is turned on, and animation will stop when turned off.

Icons on the screen will reflect the speed or state of the devices running on your spa. When an accessory has more than one speeds press the button until it reaches the desired speed.

WATER TEMPERATURE

The temperature shown at the bottom of the screen shows the current water temperature. The screen shows the current water temperature. Use the Up and Down icon to set the desired temperature. The set point will appear in blue. After 3 seconds without any change to the set temperature value, the current water temperature will reappear.

When the set value is lower than the current temperature Cooling to xx.x will appear below. When the set value is higher than the current temperature, Heating to xx.x will be indicated under the value. Normally there is a short delay before the heating starts, during which Heating Suspended is indicated under the value.

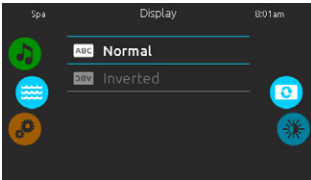

DISPLAY ORIENTATION

To modify the display orientation settings, slide the right wheel until the display orientation icon is highlighted in the middle. Simply touch the line of the orientation you want to select.

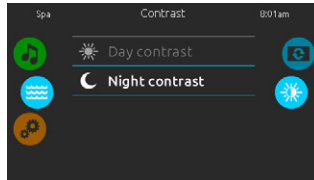

DISPLAY CONTRAST

To modify the display contrast settings, slide the right wheel until the display contrast icon is highlighted in the middle. Simply touch the line of the contrast you want to select.

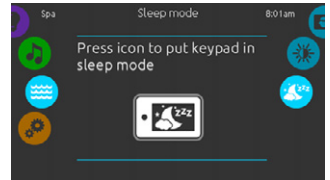

SLEEP MODE

Press key to go directly into the sleep mode. In sleep mode, water splashing on the keypad can't inadvertently start/stop a pump.

SWIM SETTINGS

The endless swimming experience is only available through the swimming programs, exclusively in the W-flow pools.



To access your swim spa training drills, touch the swimmer icon on the left.

Before choosing one, we recommend to adjust the parameters. Touch the settings icon on the right icon wheel.

From there, you can access 5 different parameters.

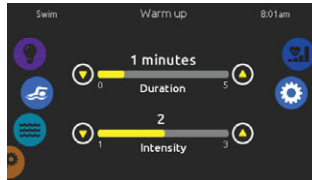

The first one is Warm up. There, you can adjust the duration and intensity of your training warm-up by touching the up and down arrows.

Once done, touch the settings icon to go back to the main settings menu.



The second one is Cooldown. There, you can adjust the duration and intensity of your training cooldown by touching the up and down arrows.

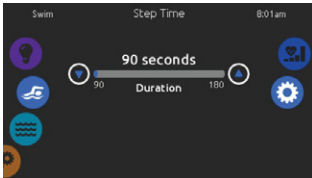

Adjust the training drill Step Time duration by touching the up and down arrows.

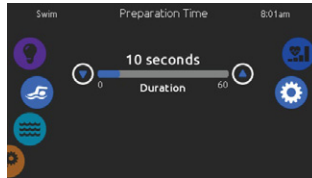

Preparation Time gives you some time to get into swimming position after touching the start button and before the pumps actually start. You can set the duration of your preparation time by touching the up and down arrows.

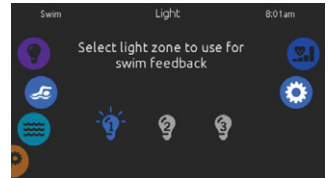

Finally, the light option gives you the possibility to select which in.mix zones you want to use for your swim feedback (requires an installed in.mix)

USER INTERFACE - SMART TOUCH

TRAINING DRILLS - ENDURANCE

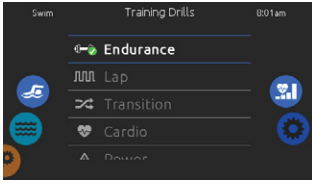

To select a training drill, touch the training drill icon on the top of the right wheel icon.

If you choose Endurance the swimming workout will be executed at a constant intensity for the entire set duration.

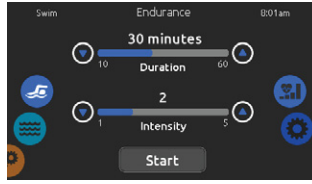

You can adjust the duration and intensity of your Endurance training drill by touching the up and down arrows.

Touch Start when ready.



The preparation countdown is displayed, allowing you to get in position before your swimming session starts. Your in.mix controlled lights will blink during the countdown (requires an installed in.mix). The keypad can be put in sleep mode by touching the sleep icon located at the top right of the screen. It will prevent interruptions of your swim session from water splashing on the keypad display.

You can touch Pause or Stop whenever you need.

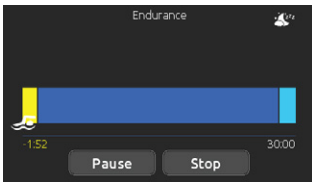

During the workout session, you can follow your progression with the swimmer icon moving toward right over the training duration bar.

You can touch Pause or Stop whenever you need.

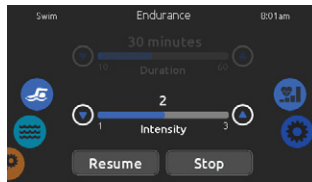

Touch Pause to suspend your swim session. You will be able to change the intensity level of your drill or go in other menus to start the music, for example.

Touch Resume when ready to swim again. The workout session will resume but the preparation countdown stop-watch won't reappear.

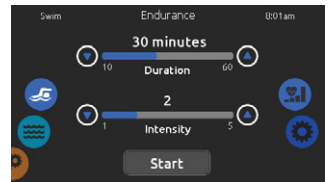

If you touch Stop to interrupt your swim session, you will be able to change the duration and/or the intensity of your session, select another training drill or modify any other parameters.

Touch Start to start your workout from the beginning. The preparation countdown will start.

USER INTERFACE - SMART TOUCH

TRAINING DRILLS - LAP

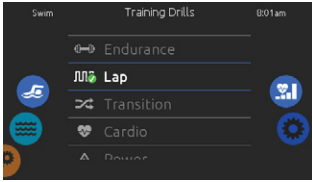

To select a training drill, touch the training drill icon on the top of the right wheel icon.

If you choose Lap, this training drill will perform high and low intensity intervals of equal step time.



You can adjust the duration and intensity of your Lap training drill by touching the up and down arrows.

Touch Start when ready.



The preparation countdown is displayed, allowing you to get in position before your swimming session starts. Your in.mix controlled lights will blink during the countdown (requires an installed in.mix).

The keypad can be put in sleep mode by touching the sleep icon located at the top right of the screen. It will prevent interruptions of your swim session from water splashing on the keypad display.

You can touch Pause or Stop whenever you need.

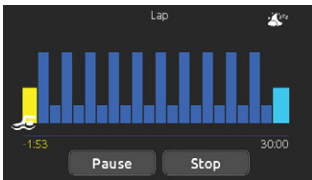

During the workout session, you can follow your progression with the swimmer icon moving toward right over the training duration bar.

Your in.mix controlled lights will change colors before each interval to inform you of the change of intensity (requires an installed in.mix).

You can touch Pause or Stop whenever you need.

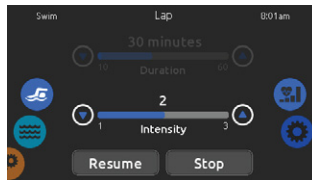

Touch Pause to suspend your swim session. You will be able to change the intensity level of your drill or go in other menus to start the music, for example.

Touch Resume when ready to swim again. The workout session will resume but the preparation countdown stopwatch won't reappear.

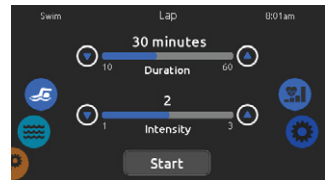

If you touch Stop to interrupt your swim session, you will be able to change the duration and/or the intensity of your session, select another training drill or modify any other parameters.

Touch Start to start your workout from the beginning. The preparation countdown will start.

USER INTERFACE - SMART TOUCH

TRAINING DRILLS - TRANSITION

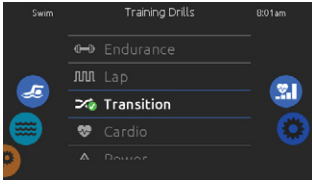

To select a training drill, touch the training drill icon on the top of the right wheel icon.

If you choose Transition, this training drill will perform a series of equal steps at random intensities.

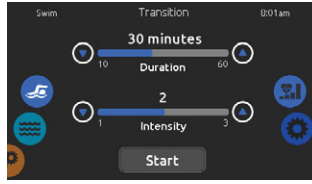

You can adjust the duration and intensity of your Transition training drill by touching the up and down arrows.

Touch Start when ready.



The preparation countdown is displayed, allowing you to get in position before your swimming session starts. Your in.mix controlled lights will blink during the countdown (requires an installed in.mix).

The keypad can be put in sleep mode by touching the sleep icon located at the top right of the screen. It will prevent interruptions of your swim session from water splashing on the keypad display.

You can touch Pause or Stop whenever you need.

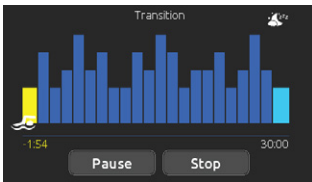

During the workout session, you can follow your progression with the swimmer icon moving toward right over the training duration bar.

Your in.mix controlled lights will change colors before each interval to inform you of the change of intensity (requires an installed in.mix).

You can touch Pause or Stop whenever you need.

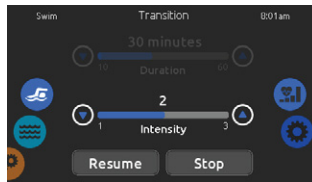

Touch Pause to suspend your swim session. You will be able to change the intensity level of your drill or go in other menus to start the music, for example.

Touch Resume when ready to swim again. The workout session will resume but the preparation countdown stopwatch won't reappear.

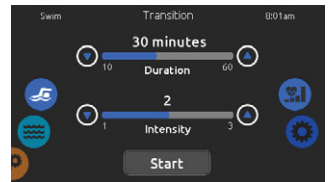

If you touch Stop to interrupt your swim session, you will be able to change the duration and/or the intensity of your session, select another training drill or modify any other parameters.

Touch Start to start your workout from the beginning. The preparation countdown will start.

USER INTERFACE - SMART TOUCH

TRAINING DRILLS - CARDIO

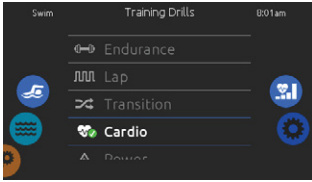

To select a training drill, touch the training drill icon on the top of the right wheel icon.

If you choose Cardio, this training drill will perform two successive steps at high intensity for one step at low intensity.

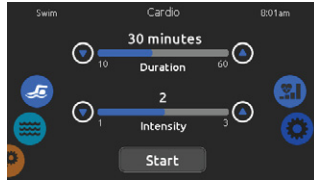

You can adjust the duration and intensity of your Cardio training drill by touching the up and down arrows.

Touch Start when ready.

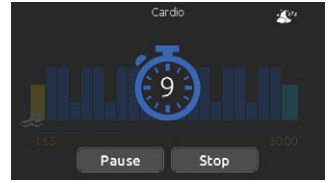

The preparation countdown is displayed, allowing you to get in position before your swimming session starts. Your in.mix controlled lights will blink during the countdown (requires an installed in.mix).

The keypad can be put in sleep mode by touching the sleep icon located at the top right of the screen. It will prevent interruptions of your swim session from water splashing on the keypad display.

You can touch Pause or Stop whenever you need.

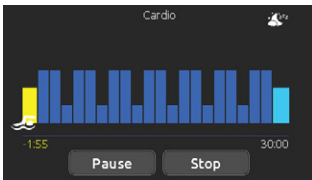

During the workout session, you can follow your progression with the swimmer icon moving toward right over the training duration bar.

Your in.mix controlled lights will change colors before each interval to inform you of the change of intensity (requires an installed in.mix).

You can touch Pause or Stop whenever you need.

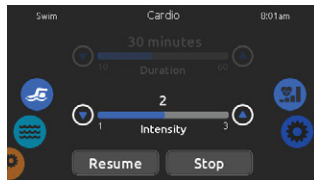

Touch Pause to suspend your swim session. You will be able to change the intensity level of your drill or go in other menus to start the music, for example.

Touch Resume when ready to swim again. The workout session will resume but the preparation countdown stopwatch won't reappear.

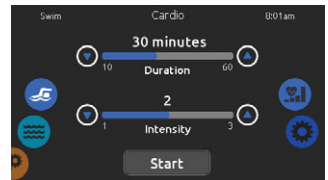

If you touch Stop to interrupt your swim session, you will be able to change the duration and/or the intensity of your session, select another training drill or modify any other parameters.

Touch Start to start your workout from the beginning. The preparation countdown will start.

USER INTERFACE - SMART TOUCH

TRAINING DRILLS - POWER

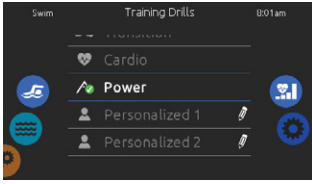

To select a training drill, touch the training drill icon on the top of the right wheel icon.

If you choose Power, this training drill will perform a pyramid program where the intensity will progressively increase until a maximum intensity level is reached. It will then decrease progressively to end at low intensity.



You can adjust the duration and intensity of your Power training drill by touching the up and down arrows.

Touch Start when ready.

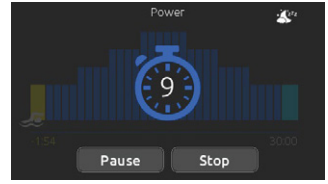

The preparation countdown is displayed, allowing you to get in position before your swimming session starts. Your in.mix controlled lights will blink during the countdown (requires an installed in.mix).

The keypad can be put in sleep mode by touching the sleep icon located at the top right of the screen. It will prevent interruptions of your swim session from water splashing on the keypad display.

You can touch Pause or Stop whenever you need.



During the workout session, you can follow your progression with the swimmer icon moving toward right over the training duration bar.

Your in.mix controlled lights will change colors before each interval to inform you of the change of intensity (requires an installed in.mix).

You can touch Pause or Stop whenever you need.

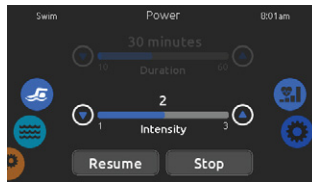

Touch Pause to suspend your swim session. You will be able to change the intensity level of your drill or go in other menus to start the music, for example.

Touch Resume when ready to swim again. The workout session will resume but the preparation countdown stopwatch won't reappear.

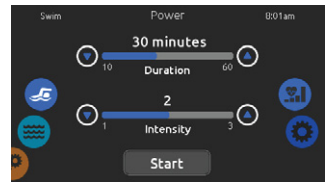

If you touch Stop to interrupt your swim session, you will be able to change the duration and/or the intensity of your session, select another training drill or modify any other parameters.

Touch Start to start your workout from the beginning. The preparation countdown will start.

USER INTERFACE - SMART TOUCH

TRAINING DRILLS - PERSONALIZED

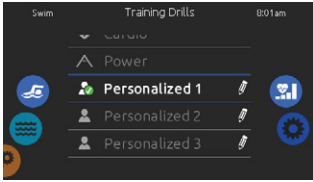

Three personalized training drills are available and can be edited to create custom workouts.

Touch the pencil icon at the right end of the desired personalized drill to open the training drill edit window.

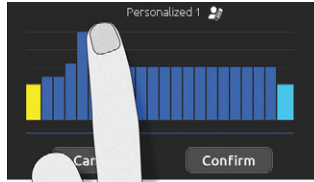

Draw with your finger the desired workout pattern on the screen.

Name your personalized training by touching the pencil icon located at the right of the workout name.



Type your workout name. Once done, touch the return key to get back to the training drill screen.

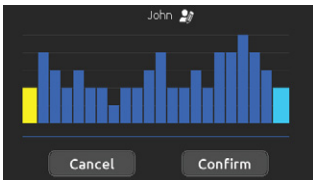

Touch Confirm to save your personalized workout. If you cancel, the modifications will not be saved.

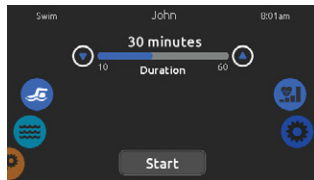

This page allows you to adjust the duration of your personalized training drill by touching the up and down arrows.

Touch Start when ready.

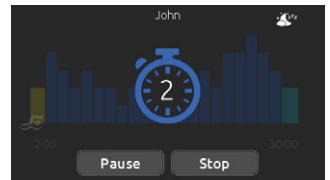

The preparation countdown is displayed, allowing you to get in position before your swimming session starts. Your in.mix controlled lights will blink during the countdown (requires an installed in.mix).

The keypad can be put in sleep mode by touching the sleep icon located at the top right of the screen. It will prevent interruptions of your swim session from water splashing on the keypad display.

You can touch Pause or Stop whenever you need.

USER INTERFACE - SMART TOUCH

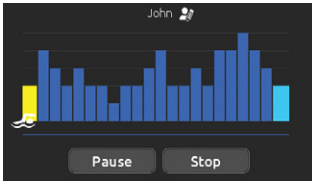

During the workout session, you can follow your progression with the swimmer icon moving toward right over the training duration bar.

Your in.mix controlled lights will change colors before each interval to inform you of the change of intensity (requires an installed in.mix).

You can touch Pause or Stop whenever you need.

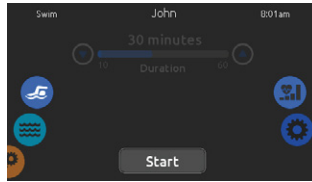

Touch Pause to suspend your swim session.

Touch Resume when ready to swim again. The workout session will resume but the preparation countdown stopwatch won't reappear.

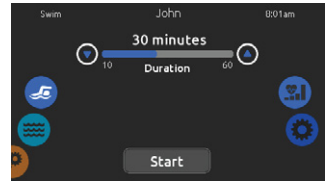

If you touch Stop to interrupt your swim session, you will be able to change the duration and/or the intensity of your session, select another training drill or modify any other parameters.

Touch Start to start your workout from the beginning. The preparation countdown will start.

USER INTERFACE - SMART TOUCH

SETTINGS

You can use the Settings mode to manage settings of your spa system.



To select the settings mode, slide the left wheel up or down until the settings icon menu is highlighted in the middle.

In the Settings page you can access the following:

- water care
- maintenance
- date & time
- keypad
- electrical configuration
- wifi
- about

To select an item, slide the right wheel until the desired icon is highlighted in the middle or press on the menu name.

WATER CARE

The Water care page will help you set up your ideal filtration and heating settings.

Choose, set or modify one of the 5 suggested modes depending on your needs at any given time.



AWAY FROM HOME

In this mode the spa will always be in economy; the set point will be reduced by 20° F.



BEGINNER

The spa will never be in economy mode and will be filtering according to the pack's low level configuration.



ENERGY SAVINGS

The spa will be in economy mode during the peak hours of the day and resume normal mode on the weekend.



SUPER ENERGY

The spa will always be in economy mode during peak hours, every day of the week.



WEEKENDER

The spa will be in economy mode from Monday to Friday, and will run normally on the weekend.

MODIFYING WATER CARE SCHEDULES

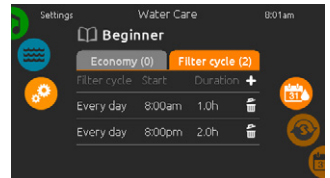
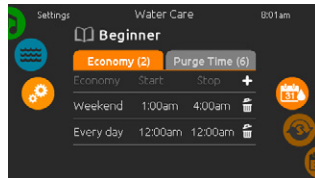
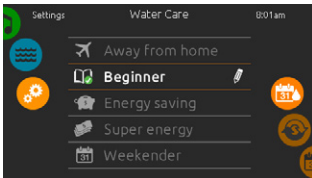

WATER CARE

To modify a Water care category, touch the pen icon at the right end of the desired water care to open the selected Water Care menu.

ECONOMY

Touch the Economy tab to change the economy schedule. You can add economy schedules by touching the « + » symbol . To delete a schedule, touch the garbage can icon at the right end of the desired line.

FILTER CYCLES

Touch the Filter cycle tab to change the filter cycle schedules. You can add filtration schedules by touching the « + » symbol . To delete a schedule, touch the garbage can icon at the right end of the desired line.

USER INTERFACE - SMART TOUCH

MODIFYING WATER CARE SCHEDULES

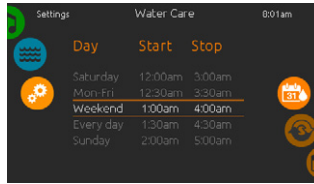

In Economy mode, the set point will be reduced by 20°F, which means that the heating system will not be engaged unless the temperature falls to 20°F below the spa's set temperature.

The filtration schedule shown on the screen will apply to the main filtration pump, most likely pump 1. If your spa uses a circulation pump configured to run 24 hours, the screen will show you the purge setting instead of filtration. The purges are pre-programmed for a fixed number of minutes, therefore the duration will be set to N/A on the screen, and only the start time can be modified.

You can modify the programmed schedules by selecting one and adjusting the schedule.

You have several possibilities for the schedule (Mon-Fri, weekend, every day, or single days). The schedules will be repeated every week. The time and duration are set in 30 minute increments.

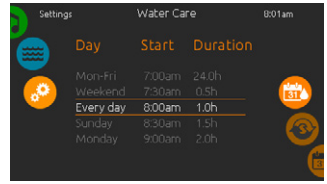

Once you have set the schedule, use the calendar icon to go back.

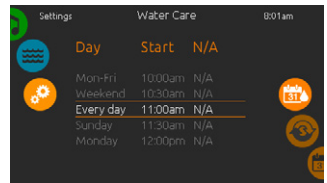
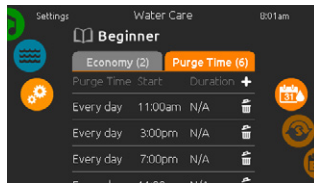

PURGES

Touch the Purge tab to change the purge settings. You can add purges by touching the « + » symbol.

To delete a schedule, touch the garbage can icon at the right end of the desired line.

You can modify the programmed purges by selecting one and adjusting the schedule.

You have several possibilities for the schedule (Mon-Fri, weekend, every day, or single days). The schedules will be repeated every week. The time and duration are set in 30 minute increments. Once you have set the purge, use the calendar icon to go back.

USER INTERFACE - SMART TOUCH

MAINTENANCE & ERROR LOG

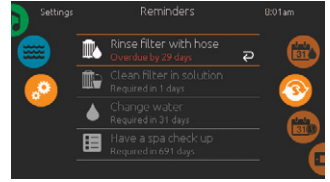
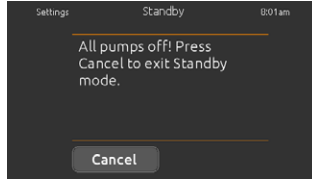
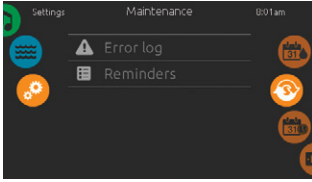

MAINTENANCE

To modify maintenance settings, slide the right wheel until the maintenance icon is highlighted in the middle.

From the Maintenance page you can access the following:

- Error log
- Reminders

Simply touch the line of the item you want to change.

STANDBY

The Standby mode allows you to service your spa. Pumps will stop for 30 minutes and will automatically restart after.

The normal page will return at the end, once the pumps will be restarted.

REMINDERS

Smart Touch keypad will provide reminders about maintenance required on your spa, like rinsing or cleaning the filter. Every task has its own duration, based on normal use.

The reminders menu allows you to check the time left before maintenance is required, as well as to reset the time once a task has been completed.

To reset a task, select it by pressing the curved arrow, then confirm when prompted. Once you have confirmed, the task will be reset.

DATE AND TIME

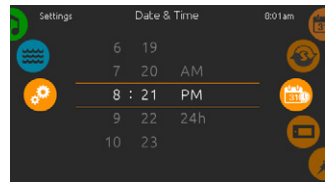
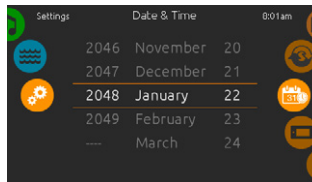
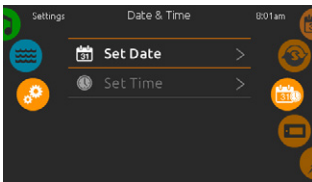

DATE AND TIME

To modify date and time settings, slide the right wheel until the date and time icon is highlighted in the middle.

Simply touch the line of the item you want to change.

SET DATE

Here you can adjust the year, month and date. Simply swipe up and down the column you want to change, and select the desired value. When done, touch the calendar icon at the right of the screen.

SET TIME

Here you can change the hour, minute and time format. Simply swipe up and down the column you want to change, and select the desired value. When done, touch the calendar icon at the right of the screen.

KEYPAD SETTING

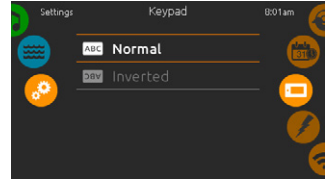
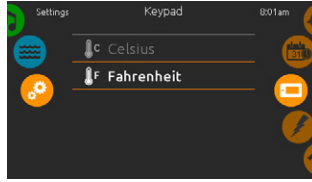
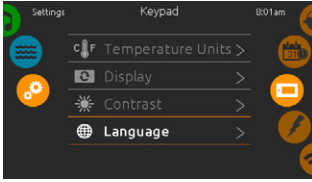

KEYPAD SETTINGS

To modify keypad settings, slide the right wheel until the keypad icon is highlighted in the middle.

Simply touch the line of the item you want to change.

TEMPERATURE UNITS

Use this page to set or change the temperature in F° or C° units.

DISPLAY ORIENTATION

Use this page to set or change the normal or inverted display orientation.

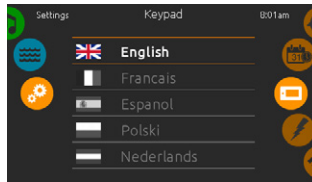
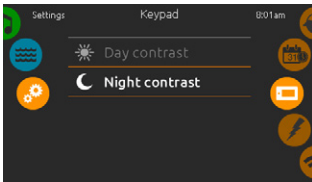

DISPLAY CONTRAST

Use this page to set or change the display day or night contrast.

DISPLAY LANGUAGE

Use this page to set or change the display language.

KEYPAD LOCK/UNLOCK

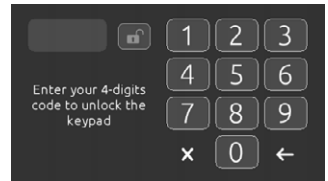
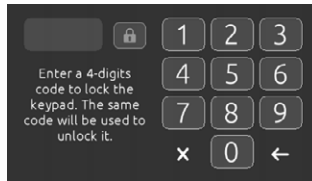
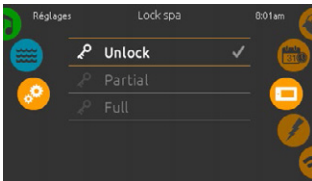

When this option is enabled, the user can partially or completely lock the keypad. When the user wants to lock the keypad he is asked to select a 4-digit code. The same code will be needed to unlock the keypad. Next time he wants to lock the keypad, he will be prompted again to select a 4-digit code (same functionality as a Safe in a hotel room).

The keypad can be unlocked with a universal unlock code (3732) or by a reset of the keypad.

When Full Lock is selected, all functions are locked.

In Partial Lock, you may only activate accessories. Settings may not be changed in this mode.

USER INTERFACE - SMART TOUCH

WIFI

(This function is available only if an in.touch module is connected to your system.)



WIFI SETTINGS

To modify wifi network settings, slide the right wheel until the wifi icon is highlighted in the middle.



WIFI NETWORKS

After a few seconds the available networks will appear on the screen, as well as their signal strength.

Selected network will be identified by a green check mark.

Swipe Up or Down the list to select your network.



WIFI NETWORK PASSWORD

If the wifi network is password protected, enter it when keyboard prompts. Use Enter key to validate the password.

If no password is required the in.touch will connect automatically.

WIFI



IN.TOUCH MODULE NOT CONNECTED

If the in.touch module of your spa system is not connected, this message will be displayed.

WI-FI (in.touch 2)

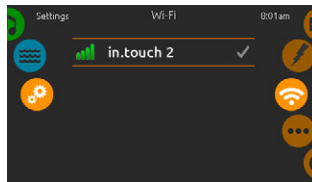

When an in.touch 2 is detected, this network will appear.

MISCELLANEOUS

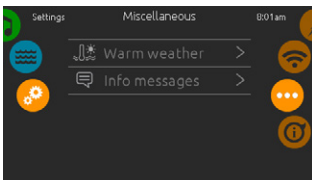

This menu gives access to modify the Warm Weather option and info messages in the media center.

WARM WEATHER

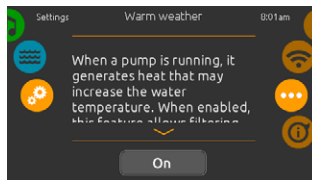

When pumps are running, they produce heat that may increase your water temperature. "Warm Weather" option gives you the option to bypass the pack filtration over temperature feature. When Warm Weather is "OFF" the filtration over-temperature is disabled and your spa filtering will continue even if the water temperature is high.

ABOUT YOUR SPA SYSTEM

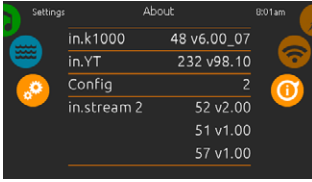

ABOUT

To get info about your spa system, slide the right wheel until the about icon is highlighted in the middle.

Information about Smart Touch software number and the revision numbers of the different components of your system will be displayed.

ELECTRICAL CONFIGURATION

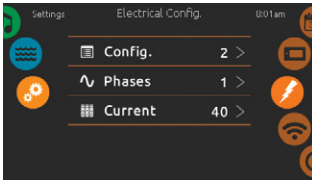

Please do not make changes in this section unless you are a qualified electrician.

A password will be required. Please contact a representative in order to obtain that password.



To change the low-level configuration, the number of phases and the input current of your spa system, slide the right wheel until the electrical configuration icon is highlighted in the middle.

USER INTERFACE - SMART TOUCH

AUDIO MODE

(only available if the system detects a connected Aquasoul Pro audio station)



To select the audio mode, slide the left wheel up or down until the audio icon menu is highlighted in the middle.

In the Audio page you can access the following:

- Aquasoul Pro on/off
- speaker calibration
- audio source selector
- bluetooth pairing

To select an item, slide the right wheel until the desired icon is highlighted in the middle.

ON/OFF

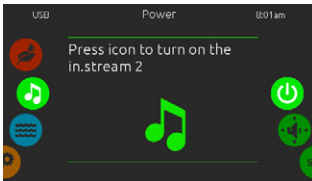

TURN AQUASOUL PRO ON

Slide the right wheel until the power on/off icon is highlighted in the middle. Press on the audio icon at the center of the screen to turn Aquasoul Pro on.

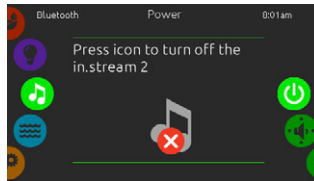

TURN AQUASOUL PRO OFF

Press on the audio icon in the center of the screen to turn Aquasoul Pro off.



MAIN DISPLAY

Press Play / Pause to start or pause playback of audio files.

Drag the volume slider to adjust the volume or tap the mute button to mute or unmute sound.

Press the last track or next track buttons to go to the previous song or skip to the next.

USER INTERFACE - SMART TOUCH

SPEAKER CALIBRATION

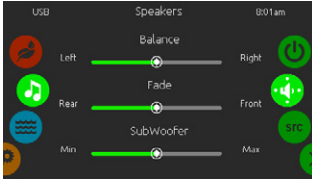

TO CALIBRATE YOUR SPEAKERS

Slide the right wheel until the speaker calibration icon is highlighted in the middle.

You can calibrate:

- balance
- fade
- subwoofer

Use the sliders to calibrate the speakers at the desired level.

The fade and subwoofer sliders will only appear on the screen if the corresponding speakers are installed on Aquasoul Pro.

AUDIO SOURCE SELECTOR

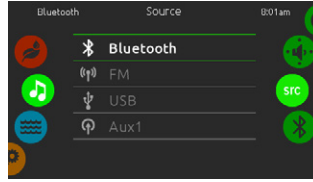

TO SELECT AN AUDIO SOURCE

Slide the right wheel until the source icon is highlighted in the middle.

In the menu list, the following sources are available:

- Bluetooth
- FM
- USB
- Aux. 1

Simply select the desired one to use.

Note that only the sources installed on Aquasoul Pro will be displayed in the source menu.

Please note that the Play/Pause and Change Track functions apply to devices using Bluetooth technology and USB, and will not work when AUX is selected as the source.

Please refer to the Aquasoul Pro connexions section to learn how to connect your Bluetooth device.

BLUETOOTH PAIRING

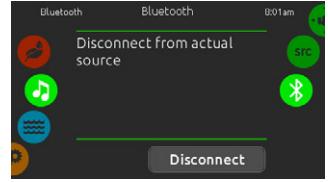

If you are using a device with Bluetooth technology, it must be connected for functions to work.

Slide the right wheel until the bluetooth icon is highlighted in the middle. Then follow the instructions displayed on the screen.

If a device with Bluetooth technology is connected to Aquasoul Pro, you can disconnect it by pressing the Disconnect button at the bottom of the screen.

Doing so will also prevent Aquasoul Pro from automatically reconnecting to this specific device until it has been reconnected using the device itself.

SANITIZATION MODE

(only available if the system detects a connected in.clear water sanitation system)

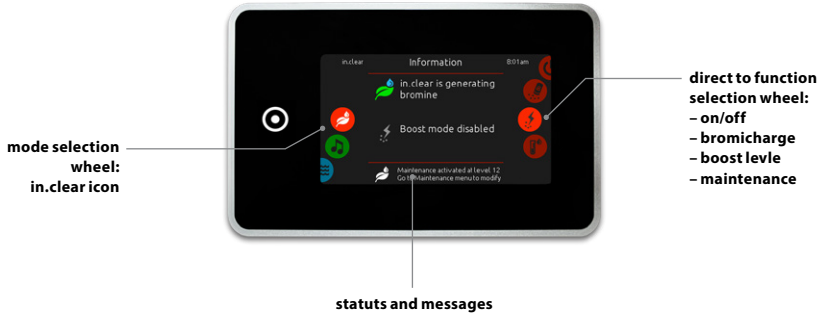

To select the sanitization mode, slide the left wheel up or down until the in.clear icon menu is highlighted in the middle.

In the sanitization page you can access the following:

- in.clear on/off
- bromicharge
- boost level
- maintenance level

To select an item, slide the right wheel until the desired icon is highlighted in the middle.

ON/OFF



TURN IN.CLEAR ON

Slide the right wheel until the power on/off icon is highlighted in the middle. Press on the in.clear icon to turn in.clear on.

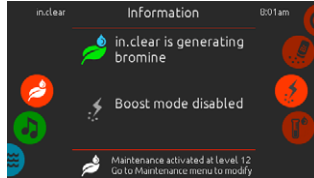

IN.CLEAR ACTIVITY SCREEN

The in.clear activity info screen will appear on the display.

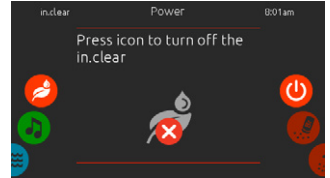

TURN IN.CLEAR OFF

Press on the power on/off icon to turn in.clear off.

BROMICHARGE™ LEVEL

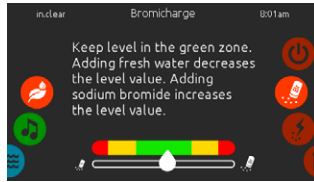

When performing a test, the BromiCharge™ gauge indicates the approximate sodium bromide level of the spa water.

To perform a water test, slide the right wheel until the add BromiCharge™ icon is highlighted in the middle.

The green zone in the center area of the gauge should be targeted for optimal performance.

There is no need to add sodium bromide if the indicator is in the green zone.

When adding sodium bromide, the gauge indicator will gradually shift to the right. When adding clean water to the spa, the indicator will shift to the left.

In order to achieve the proper level, start pumps and add 227g (.5 lb) of BromiCharge™ at a time and always allow 5 minutes for the gauge to react before adding more sodium bromide.

BOOST LEVEL

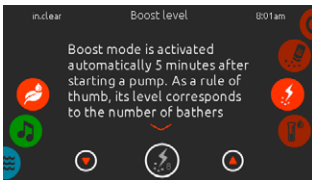

MODIFY THE BOOST LEVEL

Boost mode is activated automatically 5 minutes after starting a pump. Boost mode increases the bromine generation rate to keep the water clear, clean and soft. As a rule of thumb, its level corresponds to the number of bathers.

To modify the boost level, slide the right wheel until the boost icon is highlighted in the middle and use the up or down arrow keys to adjust the level.

Click on the the level icon to confirm your selection.

MAINTENANCE LEVEL



Use a test kit to check the bromine level. It should be between 3-5 ppm. If the bromine level stays within that range for 3 consecutive days, your maintenance level is well adjusted.

MODIFY THE MAINTENANCE LEVEL

To verify or modify the maintenance level, slide the right wheel until the maintenance icon is highlighted in the middle.

The recommended maintenance level is 12.

Use the up or down arrow keys to adjust the level.

Note that the level can be adjusted by increment of 2 using the up and down arrow keys.

If you do, retest the bromine level the day after. If the bromine is not in the 3-5 range and is higher than 5 ppm, decrease the maintenance level. If the bromine is lower than 3 ppm, increase it. Repeat until the test reads a bromine level in the 3-5 range.

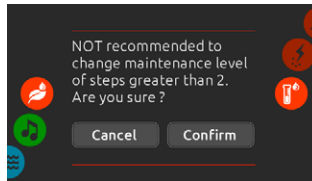

Please note that it is not recommended to change the maintenance level at steps greater than 2.

A confirmation will be asked by the system if you do.

COLOR MODE

(only available if the in.mix is detected among the spa accessories)

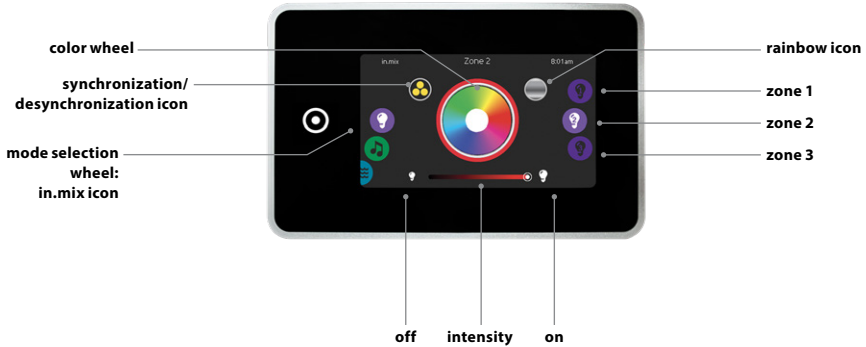

By default, the in.mix selects Zone 2 when you access the menu. To select the color mode, slide the left wheel up or down until the in.mix icon menu is highlighted in the middle.

In the color page you can access the following:

- zone selection
- changing colors
- on/off
- synchronizing zones
- intensity

IN.MIX FUNCTIONS

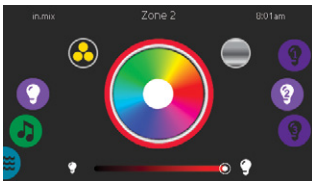

ZONE SELECTION

To select a zone, turn the right wheel until the desired icon is highlighted in the middle. This selection allows you to modify its color.

CHANGING COLORS

Once a zone has been selected, use the color wheel to choose the desired color, or the rainbow icon to get changing colors.

The rainbow icon alternates between slow transitions, fast transitions and normal color selection.

ON/OFF

There are two ways to turn the in.mix on or off. The first one is by using the Light icon on the SPA Screen. The second way is by touching the light bulb icons located each side of the intensity bar.

SYNCHRONIZING ZONES

The synchronization/desynchronization icon allows you to match the color of the selected zone with the other zones.

INTENSITY

Located at the bottom of the screen, the slider allows you to modify the intensity of the color.

USER INTERFACE - SMART TOUCH

TOO MUCH WATER ON DISPLAY



WIPE SCREEN

This message appears when too much water is detected on the touch screen. Simply wipe away excess water.

INSTALLATION ERROR MESSAGES

Upon connecting Smart Touch to your spa system you may see one of two error messages. Please follow the instructions in the message or contact your dealer for more information.

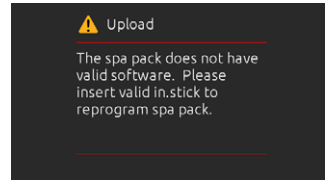
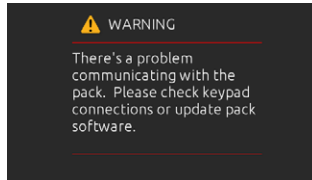

Error messages on the screen list and definitions:
<http://geckkokeypads.com/k1000errormessages>

SMART WINTER MODE (SWM)

There is a thermometer sensor in the control unit that measures the temperature of the machinery. It monitors how cold it is outside the cover - including the insulation - and turns on the motors from time to time to direct hot water into the machinery to avoid freezing.

The SWM (Smart Winter Mode) will not turn on if the sensor measures above 21C. However, if it falls below that, it will turn on for 24 hours.

- if it measures 20-16 degrees, it will run the motors for 1 minute every 2 hours.
- if it measures 15-13 degrees, it will run the motors for 1 minute every hour.
- if it measures 12-11 degrees, it will run the motors for 1 minute every 30 minutes.
- if it measures 10 degrees (or less), it will run the motors for 1 minute every 15 minutes.

This is a safety function which cannot be turned off!

WARM WEATHER FUNCTION

During the filtration cycle, the kinetic heat generated by the circulating motors is transferred to the pool water, so the pool water temperature can possibly rise above the set temperature on the control panel. The control unit continuously monitors the water temperature during the filtration cycle and if it rises above the set temperature by more than 3 degrees celsius, it automatically shortens the duration of the filtration period so the water does not overheat.

Besides continuously measuring the water temperature, it automatically changes the duration of the filtration period, but filters for at least 4 hours if the spa is equipped with a circulating motor, or for at least 2 hours if the water is filtered by the massage motor.

This function can only be turned off on whirlpools equipped with a colour touch screen.

USER INTERFACE - USING THE TURBINE



USING THE TURBINE

SWITCHING THE TURBINE OFF AND ON:

Switch on the turbin pump icon on the k1000 Smart Tuch after that the unit can be switched on by pushing the  button.
After 7-10 seconds, the turbine will start to operate at minimum speed.

The unit can be switched off by pushing the  button.
The speed of the turbine will decrease, and is switched off after 5-6 seconds, turn off the pump icon on the k1000 Smart Touch.

SPEED CONTROL:

-  the counter-current speed can be increased by pushing the button (7 speeds).
-  the counter-current speed can be decreased by pushing the button (7 speeds).
-  the control button lighting is active for 10 seconds after pressing a button.

Buttons **P1; P2; P3; P4** are not used for our pools.

WARNING!

When the turbine is switched on, the rotor is always moving at minimum speed at least.



REMOTE CONTROL WITH
IP67 PROTECTION RATING

USER INTERFACE - 4 AND 1 SINGLE BUTTON PANEL

4 BUTTON PANEL

AUXILIARY KEYPAD FOR YOUR SPA

The 4 button panel is an auxiliary keypad designed to be installed as a second keypad on your spa.

It allows you to run the accessories while staying comfortably seated in your spa.

Its surface mount allows for an easy installation in different locations around your spa.

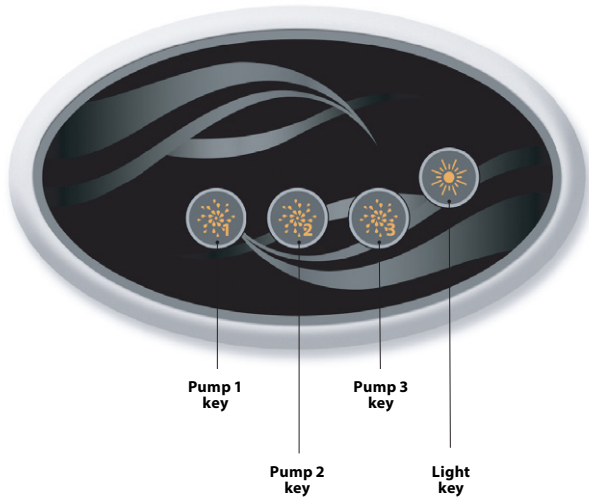

ONE SINGLE BUTTON PANEL

AUXILIARY KEYPAD FOR YOUR SPA

This one single button panel is also an auxiliary keypad designed to be installed as a second keypad on your spa.

It allows you to activate the spa pump associated to its respective section.

The panel surface allows for an easy installation in any location around your spa.



OPTIONAL ACCESSORIES - AQUASOUL PRO

AQUASOUL PRO

AUDIO STATION FOR SPAS



Aquasoul Pro audio system offers you the perfect means to bring music into your spa. Aquasoul Pro is simple to install and compatible with numerous audio sources. For example, you may connect Aquasoul Pro to an iPod using the auxiliary audio input or play music wirelessly using a Bluetooth mobile device. Listen to music in MP3 format saved on a USB flash disk or tune in to an FM station of your choice using the Aquasoul Pro integrated FM receiver. Depending on the configuration used, Aquasoul Pro can handle up to 4 speakers and one subwoofer.

The audio station can be used to charge most mobile devices on the market with its onboard USB charger controller.

Powered with its own internal universal power supply, Aquasoul Pro can be used in any place in the world. All the electronics circuits are contained in a innovatively designed and splashproof plastic enclosure.

Aquasoul Pro is equipped with state of the art class D audio amplifiers. This type of amplifier is very power efficient and dissipates much less heat than any comparable audio system for use in spa.

Depending on the selected configuration, Aquasoul Pro conveniently lets you control music from the main keypad or may be used as a stand-alone.

Main characteristics

- Fully splashproof (IPx5)
- Integrated universal power supply
- 1 auxiliary input
- Compatible USB port
- Integrated FM receiver with external antenna
- Bluetooth receiver
- Mobile device USB charger controller
- Up to 4 speakers and one subwoofer

OVERVIEW

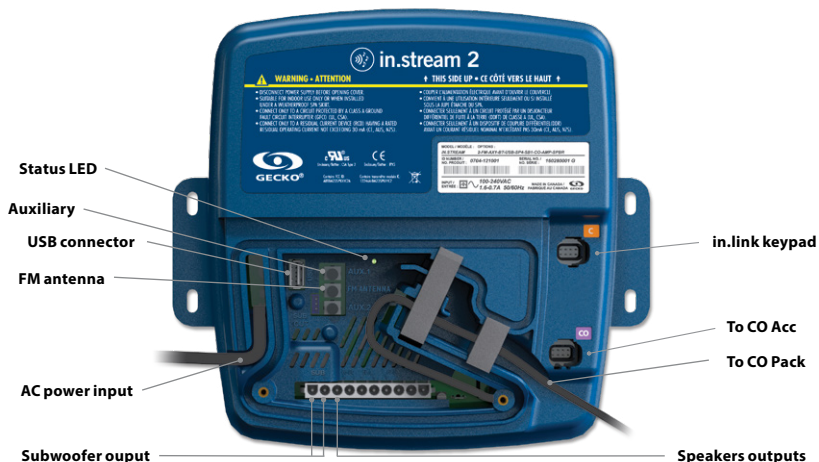

OPTIONAL ACCESSORIES - AQUASOUL PRO

Depending on the chosen configuration, Aquasoul Pro can support up to 4 speakers, 1 subwoofer, an auxiliary input, a USB connection with 1A charging capability, FM radio receiver and Bluetooth streaming.

The in.p4 waterproof enclosure, which provides protection to your iPod or smart phone, is available as an option.

With a compatible keypad, you will have full control over the Aquasoul Pro features from inside of your spa.

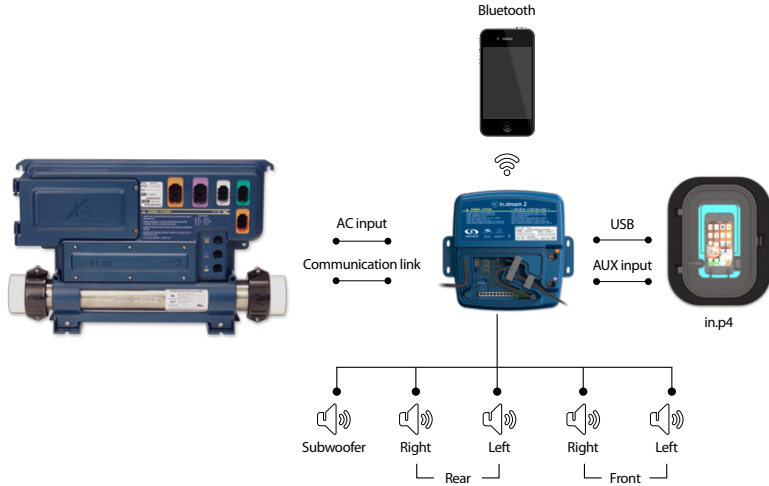

CONNECTIONS

PREPARATION



TO PREVENT ELECTRIC SHOCK HAZARD, DO NOT CONNECT TO MAIN POWER SUPPLY WHILE THE COVER IS REMOVED.



Remove the cover screws from the front of the apparatus with a Phillips screw driver.



Remove cover and put aside the foam gaskets located in the wire channel.

OPTIONAL ACCESSORIES - AQUASOUL PRO

CONNECTIONS

CONNECTING THE SPEAKERS AND SUBWOOFER



Connector pins	Identification
1	Front Left speaker (+)
2	Front Left speaker (-)
3	Front Right speaker (-)
4	Front Right speaker (+)
5	Rear Left speaker (+)
6	Rear Left speaker (-)
7	Rear Right speaker (-)
8	Rear Right speaker (+)
9	Subwoofer (+)
10	Subwoofer (-)

The speakers and the subwoofer output terminals are located on the 10-pin MATE-N-LOK connector marked "SUB R-R R-L F-R F-L"



CAUTION: AQUASOUL PRO DOES NOT COME WITH SPEAKERS AND ASSOCIATED WIRING. THE INTERCONNECTION BETWEEN THE AUDIO SYSTEM AND THE SPEAKERS MUST BE "CLASS 2 WIRING" AND BE DONE BY QUALIFIED PERSONNEL.



To connect your own speaker cable or to connect the optional adaptor, insert the 10-pin connector into the appropriate connector. Route the wires through the molded strain relief channel as illustrated.

OPTIONAL ACCESSORIES - AQUASOUL PRO

CONNECTIONS

PAIRING WITH A BLUETOOTH ENABLED DEVICE

Aquasoul Pro can play music from any device equipped with Bluetooth wireless technologies, however, you must pair your mobile device to the audio receiver in order to do so.

The system is ready to pair when it is not already connected to another device. To pair your device, make sure that you are close enough to the Aquasoul Pro, that it is turned on and that it is set in Bluetooth mode.

FOLLOW THESE STEPS TO PAIR YOUR DEVICE

1. Open the Bluetooth settings on your device. The location of the settings will depend on the device you are using.
2. Make sure Bluetooth is on.



3. Select "in.stream 2" in the list of discoverable Bluetooth devices detected nearby.
4. When prompted, enter 5555 as the PIN Code.



NOTE: In basic configuration (not connected to a keypad or controller), Aquasoul Pro is set in Bluetooth mode. Otherwise, please refer to your specific keypad operating manual for details on the Aquasoul Pro functions.

5. Once the pairing is done, select in.stream 2. When "connected" is displayed, Aquasoul Pro will be ready to start playing the selected audio.



Note: If the device moves out of range and loses connection, it should reconnect automatically as soon as it is close enough. This should happen without having to go through the menu again.

Aquasoul Pro will keep up to 8 devices in its memory. If one of the last three connected devices is in range and has its Bluetooth turned on, it will automatically connect to Aquasoul Pro.

If multiple devices are within range and have already been paired with Aquasoul Pro, priority will be given to the device that was first detected in the Aquasoul Pro memory.

OPTIONAL ACCESSORIES - MY MUSIC

MY MUSIC

NO EXTERNAL CONTROL UNIT



1. Listening to music via Bluetooth

1.1 Pairing Bluetooth devices

1. Turn on the Bluetooth device
2. Select ProwBT/MyMusic from the available devices and pair it (no password needed). Only one Bluetooth device can be paired with the Bluetooth Media Player at a time.

1.2 Listening to music via Bluetooth device

1. The Bluetooth mode is activated as soon as it is paired with a Bluetooth device.
2. Play music on the device and the Bluetooth Media Player will provide the sounds.
3. Press the PLAY/PAUSE buttons to play or pause the music.
4. Press the FAST REWIND/FORWARD buttons to play the previous/next track.
5. The songs/tracks and volume can be set directly on your Bluetooth device or with a remote control.

We would like to inform you that the new 2.0 speakers require a PIN for connection. The PIN number is: 2288

OPTIONAL ACCESSORIES - UV-C

UV-C WATER TREATMENT

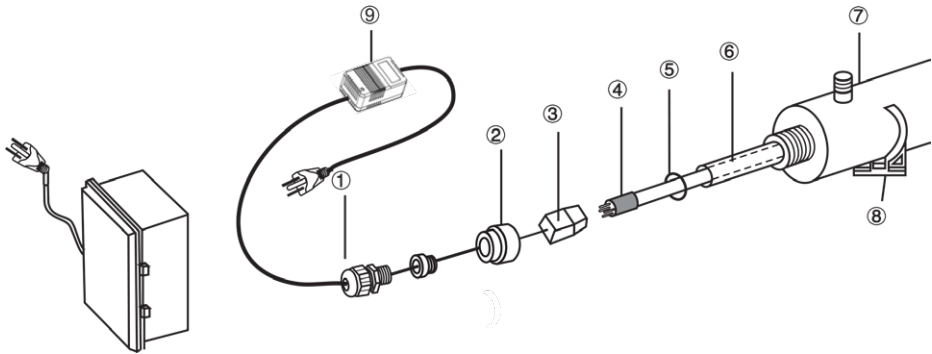

- 1- Water resistant lid
- 2- Aluminum nut
- 3- Lamp casing, wire outlet

- 4- Germicidal ultraviolet lamp
- 5- Rubber sealing ring
- 6- Quartz sleeve

- 7- Chamber
- 8- Pawl
- 9- Transformer

WARNING: THE GERMICIDAL ULTRAVIOLET RAYS ARE HARMFUL TO THE EYES, SKIN.

INTEGRATION:

1. Install the sterilization equipment at an easy to reach well lit place for effortless observation and maintenance.
2. Lock the clamp on the frame.
3. Insert the chamber with the help of the clamps.
4. Connect to the water supply.
5. Insert the quartz sleeve, sealing ring, lamp.

IMPORTANT: DO NOT TOUCH THE QUARTZ SLEEVE OR THE SIDES OF THE LAMP, ONLY HOLD IT BY THE TWO ENDS.

The ultraviolet lamp and the quartz can easily be damaged. Take care when removing or changing the lamp or the quartz sleeve.

- a. Take off the nut. (2).
- b. Carefully slide the quartz sleeve (6) from one end of the chamber to the other.
- c. Slide the sealing ring (5) onto the free end points of the quartz sleeve.
- d. Squeeze the aluminum nut on by hand (2).
- e. Slide the lamp (4) into the quartz sleeve.
- f. Connect the lamp to the casing.
- g. Screw the nut to the chamber, then screw on the water resistant lid (1) to the nut (2).
- h. Open the tap and check if the device is leaking. Repair as necessary.
- i. Plug the device into the electric supply. Use a socket equipped with a fault circuit interrupter (GFCI).

Malfunction of the UVC water sanitizer is indicated by the LED logo flashing in red. In this case, replacement of the fluorescent tube is necessary.

CHANGING THE LAMP AND SERVICING THE UV SYSTEM

Important: Do not touch the quartz sleeve or the sides of the lamp, only hold it by the ends.

1. Unplug the power plug.
2. Shut down and drain the water from the device to lessen pressure.
3. Take off the PVC lid (1) and unscrew the aluminum nut (2).
4. Carefully pull out the lamp (4) to approximately 5cm from the chamber (7).
5. Holding the lamp by the end carefully remove the lamp casing (3) on the free end.
6. Carefully take the lamp out of the chamber.
7. Carefully take off the sealing ring (5) from the end of the quartz sleeve.
8. Carefully take off the quartz sleeve.
9. To reinstall follow instructions 1 to 8 in reversed order

MAINTENANCE SUGGESTION:

In order for the sterilizer to work properly and with maximal efficiency the user should perform the following maintenance tasks.

1. Cleaning, changing the quartz sleeve:
 - a) The quartz sleeve is to be cleaned with a glass cleaner solution every 6-12 months.
 - b) The quartz sleeve is to be changed every 24 months.
2. Changing the UV lamp is recommended after 8-9000 operating hours (about 12 months of continuous operation).
3. To acquire interchangeable parts contact our headquarters or the local representatives of our company.

OPTIONAL ACCESSORIES - OZONE

OZONE DISINFECTION

FILTRATION AND OZONE

In a system without circulation engines the low setting of the massage engine and the ozone generator will switch on during filtration. In a circulation type system ozone starts in a system with circulation engine.

The system is factory programmed for an evening filtration cycle since energy prices might be lower in the evening

(assuming that the time of day is properly set). The filtration time and duration are programmable.

A second filtration cycle can be freely entered.

At the start of every filtration cycle the jets and engine start to clean the pipes and ensure proper water quality.

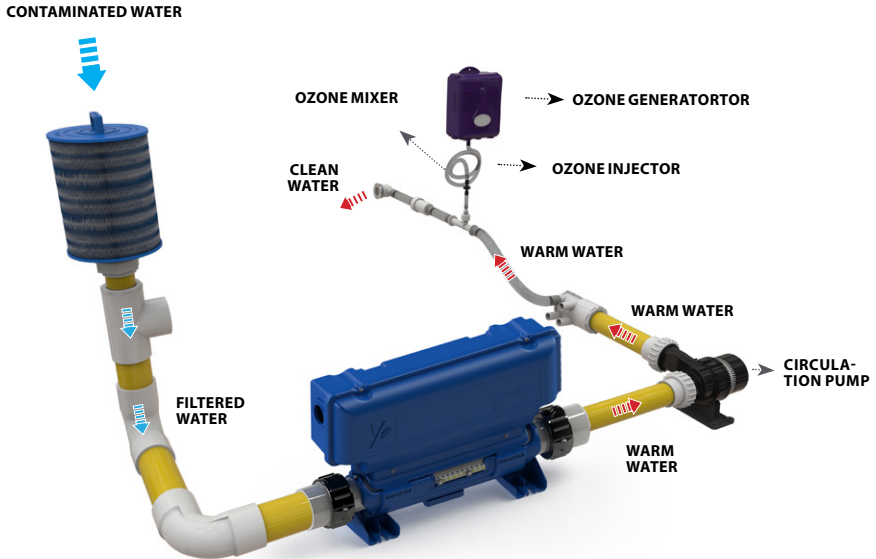

OPTIONAL ACCESSORIES - IN.GRID



in.grid

A FLEXIBLE WAY TO CONTROL EXTERNAL HEAT SOURCES FOR YOUR SPA

Our new system interface lets you select, use and synchronize alternative heat sources to efficiently keep the spa water warm. Also acts as a hub to connect up to four single button switches and one 4 button auxiliary switch.

Connected to the Y series, in.grid gives you the advantages of using alternative heating sources. Connected to the CO port of your spa control system, in.grid will act as a dispatcher of external heating sources such as your heat pump or your central house heating system.

With in.grid, you can choose one of its four modes of operation that suits you the best, depending on your external heating system and your climate. Smart modes help you taking more advantage of your external heat source to optimize your savings.

INSTALLATION

The in.grid provides a connection to a normally open dry-contact relay on a spring-loaded female connector. The connector accepts bare wire connections. The cable must be passed through the already installed watertight grommet. Use wire gage between AWG 24 and AWG 16.

Use cable with round jacket suitable for the watertight grommet. Diameter should be between 0.090" and 0.250".

The dry contact is rated for low voltage of maximum 24V and 4A.



to heat pump or central hot water system

OPTIONAL ACCESSORIES - IN.GRID

INSTALLATION WITH EXTERNAL HEAT PUMP OR GAS HEATER

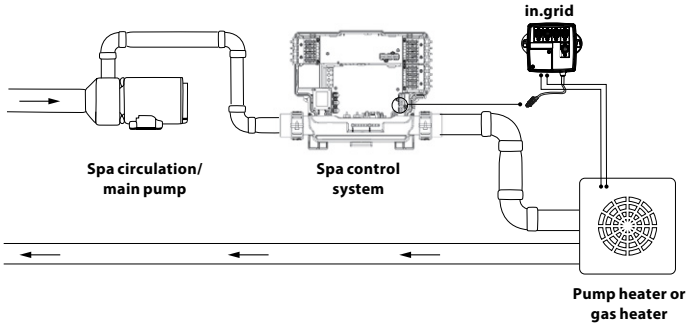

- ⚠ **IMPORTANT:** Your heat pump or gas heater must have all the flow and temperature limit protections.
- ⚠ Your heat pump or gas heater must be connected to your Y series spa control system. Make sure to always connect your external heating system in the same water pipe filter of your spa control system heater (as illustrated above).
- ⚠ The unit must be installed after your spa control system (as illustrated above).
- ⚠ You need to be sure your pump heater or gas heater is set to the maximum set point temperature. Your water temperature regulation will be controlled with your spa control system, by adjusting the set point on the spa keypad.
- ⚠ The in.grid dry contact should be hooked to the input for wire remote temperature control of the external heating system. Your voltage must be below 24 V.
- ⚠ If the in.grid controls are used with a gas heater, the remote temperature control input is usually called "fireman's switch".

INSTALLATION WITH A HEAT EXCHANGE UNIT

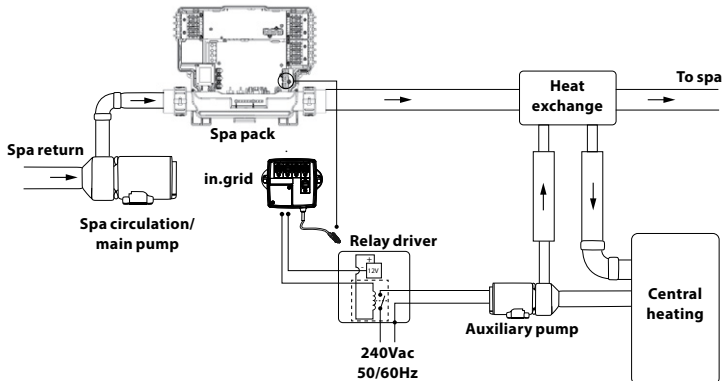

Please make sure your heat exchange does not have a flow restriction. The heater in your Y series spa control system needs a minimum of 20 GPM all the time.

Make sure to always connect your heat exchange unit in the same water pipe filter of your Y series spa control system heater.

The dry contact of the in.grid must only control a low voltage line and is used to power a low voltage relay coil. Use a relay driver to power up the auxiliary pump low voltage.

OPTIONAL ACCESSORIES - IN.GRID

Heat Mode Operations

You can choose between four different water regulation modes available. Your in.grid is automatically detected by the spa control system at power up. It will be ready to use with your preferred heat mode one minute following power up.

The relay contacts of the in.grid will be closed if the external heating system is activated. Otherwise, the relay contacts are open.

Your desired heat mode must be set by adding a jumper on one of the five (5) different positions.

***Note:** Your heat mode selection can be changed with the in.touch 2 app on your mobile device. On your app, any new selection will override the jumper setting of the in.grid. The in.touch 2 app will automatically detect the in.grid presence and will adapt its menu configuration as required.

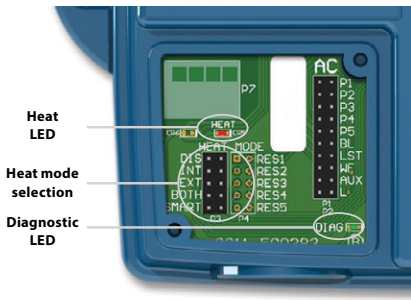

Five available heat modes are offered with in.grid:

1- DIS (DISABLED)

Use this mode if the spa configuration does not have any external heating system and only the single switch functionalities are used. This will avoid in.touch 2 application on a mobile device to display the Heat Mode Selection menu*. The spa controller will regulate the water temperature using the standard resistive heater. The single button switches will control the different spa accessories according to the AC jumper selections.

IMPORTANT: This mode can only be set with the heat mode jumpers.

2- INT (INTERNAL)

This mode provides an easy way to revert back to standard water regulation using the internal heater in case of problem with the external heating system.

** This mode can be set with your in.touch 2 app on a mobile device without the need to open the spa skirt to change the jumper setting on the in.grid. Thanks to your in.touch 2, it will be easier to set your preferred heating mode back once the external heating system is available.*

3- EXT (EXTERNAL)

Use this mode for a maximum energy saving purpose. The spa control system will only use your external heating system to regulate the water temperature. In normal operation, the internal heater will never be activated.

** This mode can be set with your in.touch 2 app on a mobile device without the need to open the spa skirt to change the jumper setting on the in.grid.*

Freeze Protection

Freeze protection has been added because EXT (EXTERNAL) mode does not allow the activation of the internal heater. In cold weather, if it becomes impossible to keep the water over freezing point, the help of the internal heater will then be needed. This is the only time the freeze protection will come in.

At any time, if the water temperature drops to 40°F (4.5°C), the resistive heater will give a boost to avoid freezing. The freeze protection will stay active until water temperature reaches the minimum allowed set point (usually 59°F / 15°C). Normal EXT mode will resume functioning thereafter.

4- BOTH (BOTH SYSTEMS ALL AT ONCE)

Use this mode for swim spas or large spas, which have bigger needs of energy to keep the water temperature at the desired set point.

The spa control system will always use the external heating system AND the internal heater simultaneously to regulate the water temperature; they are both activated or deactivated at the same time.

** This mode can be set with your in.touch 2 app on a mobile device without the need to open the spa skirt to change the jumper setting on the in.grid.*

5- SMART (ENERGY SAVINGS)

Use this mode for a better energy saving purpose, combined with a maximum water temperature regulation efficiency.

The spa control system will always use the external heating system to regulate the water temperature. If the temperature falls too far below your set point (-2.5°F), the internal heater will be activated to help your external heating system reach the set point.

Once the temperature is within 1.5°F from set point, the internal heater is deactivated and the external heating system takes all control of the water regulation again.

** This mode can be set with your in.touch 2 app on a mobile device without the need to open the spa skirt to change the jumper setting on the in.grid.*

Troubleshooting

DIAGNOSTIC LED

The diagnostic LED will help you with the status of the connection between the spa control system and the in.grid.

Blinking light: Spa control system not detected, not compatible or in Disable mode if one of your single switches doesn't operate properly.

Solid light: Spa control system detected

No light: Power Off

HEAT LED

Solid light: Relay contacts close and external heating system on.

No light: Relay contacts open and external heating system off.

WARNING:

Before installing or connecting the unit, please read the following

For optimum performance please carefully read the manual before installation.

Install the in.touch 2-co module at least 12" (30 cm) away from any metal part or any metal foil.

The in.touch 2-co module should be installed such as it can be relocated under the spa in order to obtain optimal reception after final installation of the spa in the yard.

To satisfy fcc rf exposure requirements for mobile and base station transmission devices, a separation distance of 8" (20 cm) or more should be maintained between the in.touch 2 Modules and persons during operation; to ensure compliance, operation at closer than this distance is not recommended.

The antennas used for these modules must not be co-located or operating in conjunction with any other antenna or transmitter.

To power the in.touch 2-en, only use the power supply unit provided with the in.touch 2-en.

This appliance is not intended for use by persons (including children) with reduced physical, sensory or mental capabilities, or lack of experience and knowledge, unless they have been given supervision or instruction concerning use of the appliance by a person responsible for their safety.

Children should be supervised to ensure that they do not play with the appliance.

Disposal of the product



The appliance (or the product) must be disposed of separately
In accordance with the local waste disposal legislation in force.

Compatibility requirements

in.touch 2 modules for FCC (North America) models (915 MHz):

Home and spa transmitter kit: 0608-521020, 0608-521023

in.touch 2 modules for ETSI (Europe) models (868 MHz):

Home and spa transmitter kit: 0608-521021, 0608-521024

Compatible spa packs:

in.xm2, in.xe, in.ye, in.yj and in.yt spa systems manufactured in or after 2012.

in.touch 2 application: Compatible with devices running:

iOS 8.0 or higher
Android 2.3 or higher

Router and installation requirements

Any standard router with an available 100 Mbps (wired LAN) RJ45 port can be used. The router must also have its Port 10022 open, which is normally a default setting. A 3-foot (0.9 m) Ethernet cable is included.

The home transmitter will need a main supply (120V in North America, 220V in Europe) nearby to allow connection of the transformer.

Aeware®, Gecko®, and their respective logos are Registered Trademarks of Gecko Alliance Group.

in.touch 2™, in.xm2™, in.xe™, in.yt™, in.ye™, in.therm™ and their respective logos are Trademarks of Gecko Alliance Group.

All other product or company names that may be mentioned in this publication are trade-names, trademarks or Registered Trademarks of their respective owners.



in.touch 2

Easily integrate your spa to the Internet of Things!

Simplest of setups

in.touch 2 eliminates all the complexities of connecting your spa to the Internet and transforms your smartphone or tablet into your ultimate Wi-Fi spa remote control. in.touch 2 comes with a state-of-the-art app and 2 prepared radio frequency transmitters, one being part of your spa system and the second one being connected to your Internet router. Both RF transmitters are prelinked to one another, enabling an immediate and perfect communication between you and your spa.

Strong and long range communication signal

Through their proprietary RF technology, in.touch 2 transceivers emit a strong, stable and long range signal between your spa and your router (about 3 times longer than regular Wi-Fi signal). No need for repeaters or boosters: your spa will always remain within reach in typical backyard settings.

State-of-the-art app with push notifications

in.touch 2 streamlined application makes it very easy to control and program all the functions and features of your spa from your smartphone or your tablet. Even when you're away from home, you get full control of your water care settings, filtration cycles, water temperature, economy modes and a lot more. Push notifications will always keep you informed on the status of your spa, even when your app is not open.

in.touch 2 overview

Home Transmitter (EN Module)

Spa Transmitter (CO Module)

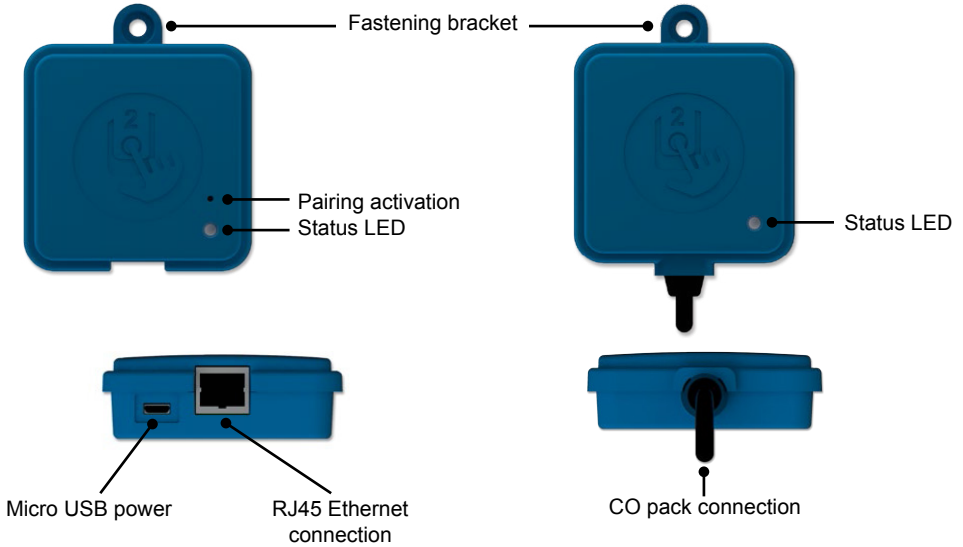

in.touch 2 dimensions

Home Transmitter (EN Module)

Spa Transmitter (CO Module)

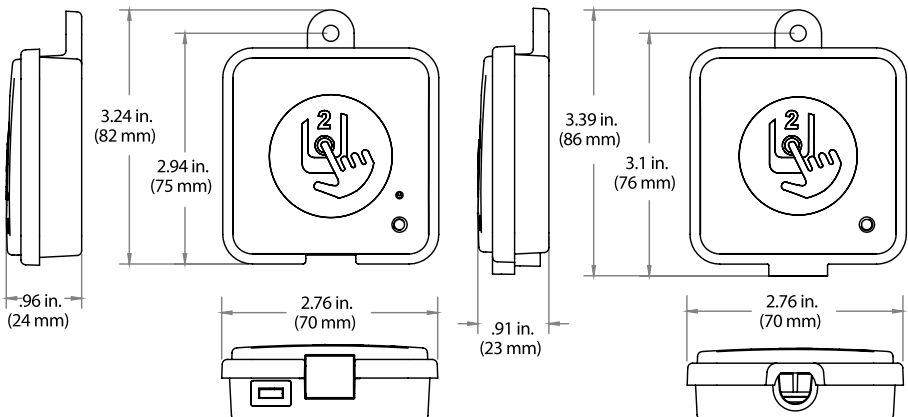

in.touch 2 Spa Transmitter (CO Module) installation

Before proceeding with any installation, be sure to turn spa power off.

The in.touch 2 Spa Transmitter unit must be installed under the spa skirt, at least 12" (30 cm) away from any metal component or structure. This is necessary to ensure optimal transmission. In some cases, it may be necessary to relocate the unit once the spa is installed in the yard to ensure proper signal transmission and distance.

Install the Spa Transmitter so the module can be repositioned to optimize the signal strength in the yard (it is possible to see the signal strength with the in.touch 2 application in the menu Setting -> in.touch network -> Signal strength).

We recommend that you install the unit with a #8 pan head screw.

Here are some suggestions for a successful installation:

- Install the unit as high as possible within the spa skirt, but keep it away from the spa frame if it is metallic.
- Route the cable and leave some slack in the Spa Transmitter cable so the Spa Transmitter can be moved around in case of reception problems.
- Install the Spa Transmitter in a corner of the spa to help avoid metallic components, accessories and piping close to the Spa Transmitter.
- The Spa Transmitter should be installed as close as possible to the house to optimize signal strength. It is recommended to install the in.touch 2 module on the side of the spa facing the house to increase the signal. A body of water between the Spa Transmitter module and the Home Transmitter will reduce the signal strength.

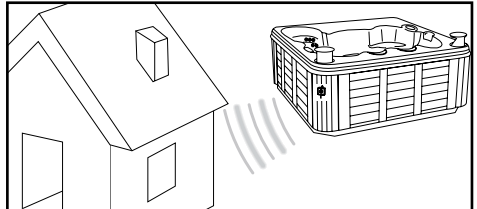
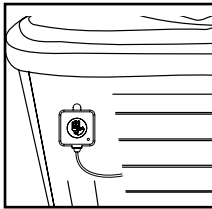

Connection of the in.touch 2 Spa Transmitter (CO Module)

Simply connect the Spa Transmitter module into an available CO port of the spa pack (or any other accessory with a free

CO port, such as the in.stream 2 audio amplifier, or the in.clear spa sanitizing system).

Note that the Spa Transmitter only has a single CO cable and thus must be installed at the end of the CO chain if more than a single accessory is installed on the same CO port of the spa pack.

Note: Before powering up the spa pack again, please go to the next step and install the Home Module (EN Module).

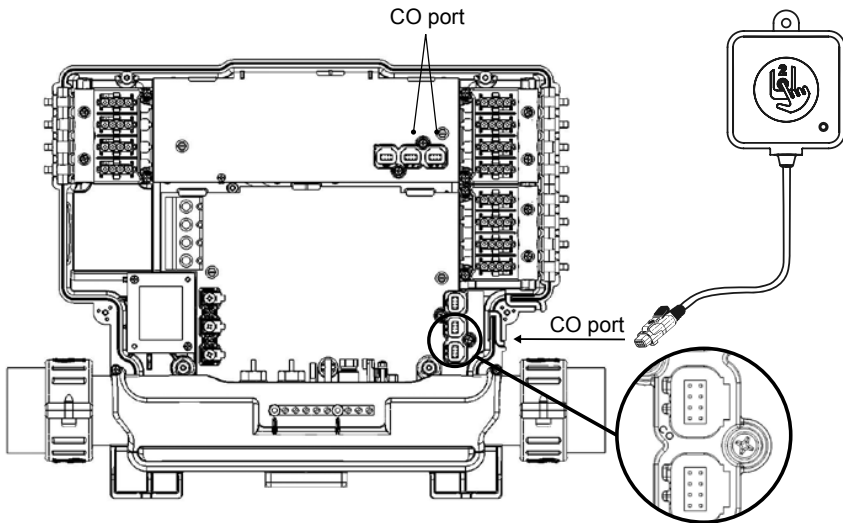

Home Transmitter (EN Module) installation

The Home Transmitter unit must be installed inside the house near the router as it needs to be connected to it. The Home Transmitter is provided with an Ethernet cable and a power supply. If required, a longer cable of good quality can be used by the installer (longer cable not provided) to install the Home Transmitter closer to the spa within the home. The only requirement for installation location is that household current be available to power the Home Transmitter using the provided wall transformer.

The Home Transmitter can be fixed in the house to optimize the signal strength. We recommend that you install the unit with a #8 pan head screw.

Here are some suggestions for a successful installation:

- If possible, install device on the first floor of your house.
- If installing in a basement, place at highest level possible and closest to a window.
- Try to install as far as possible from materials that may interfere with signal (ie. metal structures, thick cement walls).
- Install as far as possible from router as the signal emitted by the antenna may interfere with RF signal.

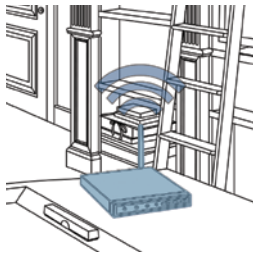

Connection of the Home Transmitter (EN Module)

Simply connect Ethernet cable into the RJ45 port of the Home Transmitter and in one of the available LAN ports on the router.

Finally, to power up the Home Transmitter, connect the provided transformer to a 120V (North American model) or 220V (European model) household supply and connect the USB cable between the transformer and the Home Transmitter.

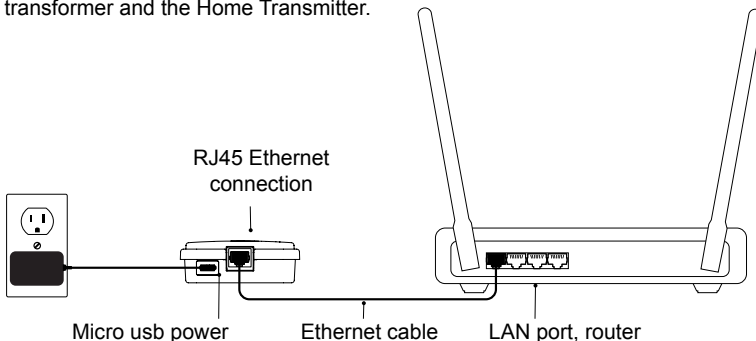

Pairing the Spa Transmitter (CO Module) and the Home Transmitter (EN Module)

The pairing process is used when you need to replace one module of the in.touch 2 kit. Otherwise, the in.touch 2 arrives pre-paired from the factory.

1. Power up the Home Transmitter

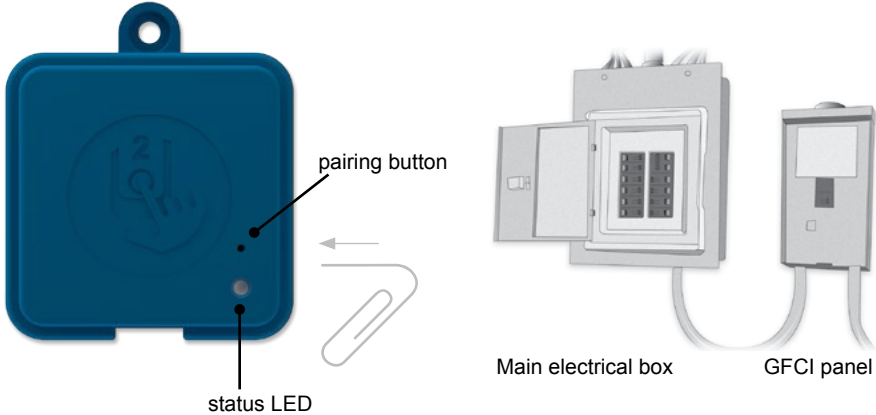

2. Press on the pairing button with a paper clip or some similar tool. When the pairing mode is active the status LED flashes YELLOW in a rapid pattern. The Home Transmitter is then in pairing mode and will remain in this mode until it pairs with an Spa Transmitter, or until it is reset (power cycled).
3. Shut off the spa's breaker (thus turning off the Spa Transmitter), wait a few seconds, and then flip the breaker back on. Within a few seconds, the pairing operation should complete and the Home Transmitter status LED will no longer be YELLOW.

Note: in.touch 2 modules can be paired as often as necessary, but can only be paired with a single counterpart module at a time. Once paired, the modules store this information permanently until the next pairing operation. Pairing information is stored in non-volatile memory, so pairing is not required after a power failure. Only a Home Transmitter can initiate a pairing, so it is important that the pairing begin with putting the Home transmitter module in pairing mode.

If several spas are powered up at the same time with a Home Transmitter in pairing mode (for instance, in a dealer showroom), only the 1st spa to successfully connect to the Home Module will pair. As this can be random, it is recommended that only 1 spa be powered up at a time during the pairing process.

OPTIONAL ACCESSORIES - IN.TOUCH 2

LED

Each in.touch 2 module has a status LED that can be used for troubleshooting purposes. The LED is located on the top of both enclosures.

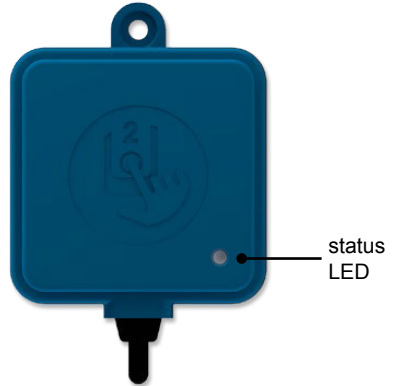
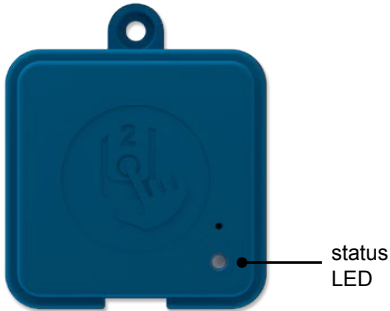

Home Transmitter

Pairing mode Yellow (Blinking)	●
Router not detected	●
Router detected	●
in.touch 2 server detected	●
Module is fully functional	●

Spa Transmitter

Pairing mode Yellow (Blinking)	●
Spa controller not detected	●
in.touch 2 server detected	●
Module is fully functional	●

* When the LED status is blinking (blue, green or red) this indicates that the communication between the EN module and the CO module is not established.

Download application

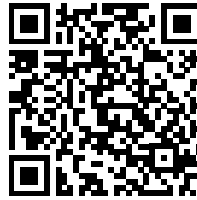
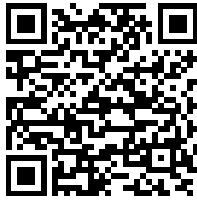

The in.touch app allows you to control your spa using your home network or an Internet connection anywhere in the world. The Wellis Spa Control (in.touch 2) app is waiting for you in the App Store for iOS devices and on Google Play for Android — search for «Wellis Spa Control» then click on it to install.

Use this application

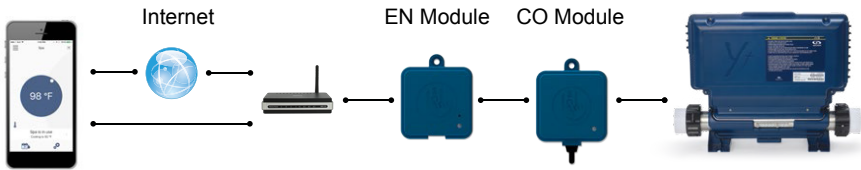

On your home network

It is possible to access your spa with the in.touch 2 app through your home network. To be able to see your in.touch 2 in the application you need to connect your device to the same router (Wi-Fi network) than the one used to connect your Home Transmitter

Go to the Wi-Fi settings section of your mobile device and choose the same network that your spa is connected to (i.e. Home). Once you've selected it, wait until your device confirms the connection.

On the Internet

The in.touch 2 allows you to use the Internet to control your spa from anywhere in the world. In order for them to communicate, both the in.touch 2 module and your device must be connected to a network that allows access to the Internet.

Once your Home Transmitter is connected to the Internet (the LED status is blue), you can use your in.touch 2 app any time your device is also connected to the Internet (wireless or cellular network), even if you are away from home.

To have access to your spa away from home, you will need to have previously linked your mobile device to your spa on your home network.

Setup your Wi-Fi on your device

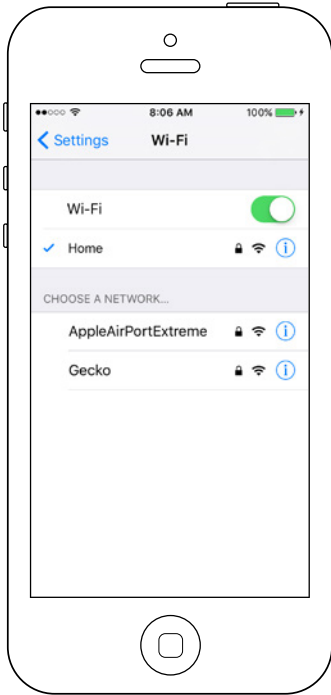

Before using your application, go to the Wi-Fi section of your device's settings. Make sure you are connected to your home network. This needs to be the same Wi-Fi provided by the router to which you connected your Home Transmitter.

Start the in.touch 2 application

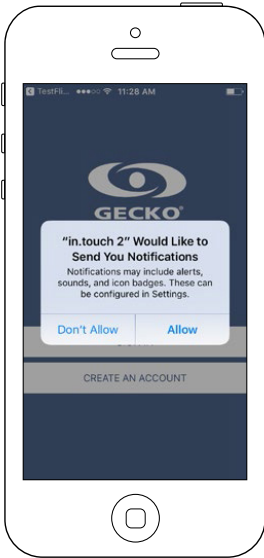

Find the icon for the in.touch 2 application, then tap on it to open it.

The first time you use the application a message will ask you: "in.touch 2" Would like to send you notifications. If you choose Allow, the application will send you notifications about the status of your spa. If you choose Don't Allow, the application will not send you notifications.

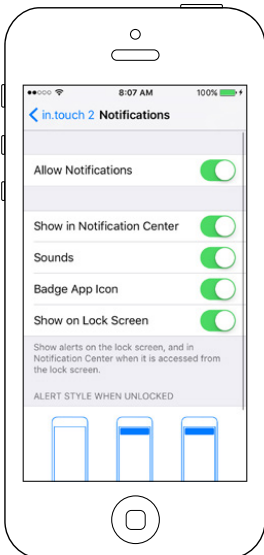

If you change your mind later concerning notifications, you may add or remove notifications for the in.touch 2 application.

On iOS, go in your settings menu and choose in.touch 2. Select the notifications menu, you can turn notifications on or off from this page.

On Android, go to your settings menu and then into the notifications menu. Select the in.touch 2 app, from this page you may turn notifications on or off.

Login page



Before using your application, you must create an account first and then, you'll be able to sign in. Your account will give you the opportunity to have access to your spa from any in.touch 2 application.

New account creation

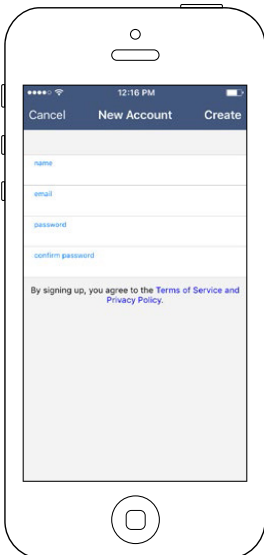

When you choose to create a new account, you agree at the same time our Terms of Service and our Privacy Policy. You can read them at any time through this link: <https://geckointouch.com/legal>

Choose a spa

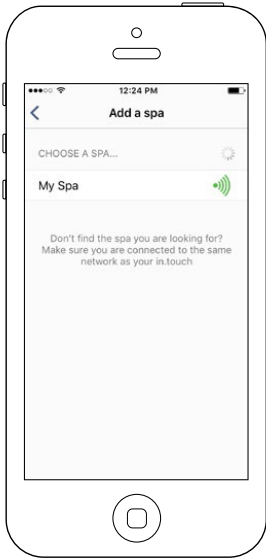





This page displays all the spas detected by your application.

To detect your spa, you need to connect your mobile device to the same network to which you connected your Home Transmitter.

Once you have done a connection with the spa its name will be saved on this page to allow you to connect to this spa from anywhere.

To add a spa later on, go to p. 26 of this techbook for instructions. The RF signal strength (communication between the two in.touch 2 transmitters) is illustrated on the Select a spa page. There are 5 possible states:

-  • Signal superior to 80%
-  • Signal between 80% and 51%
-  • Signal between 50% and 31%
-  • Signal below 30%
-  • The Spa Transmitter is not available

Home page

The main screen gives you access to your accessories, water temperature, water care and settings.

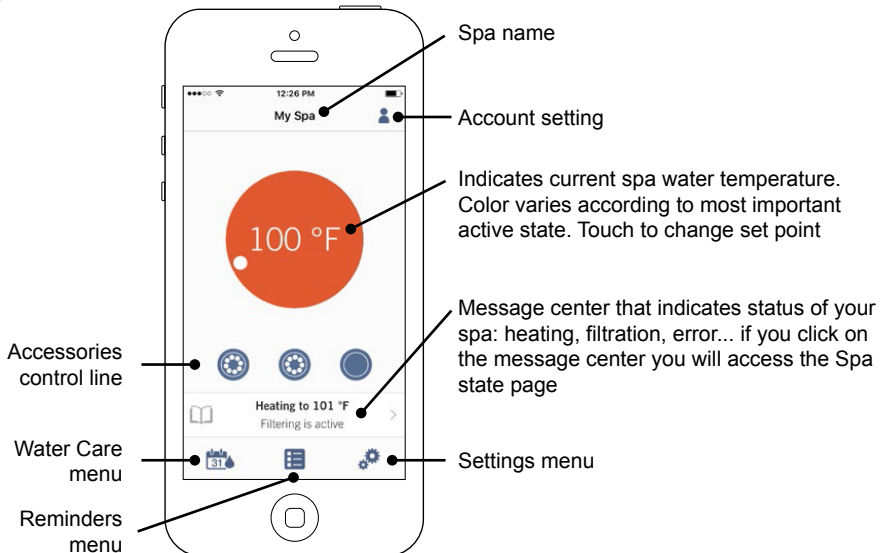

Spa state

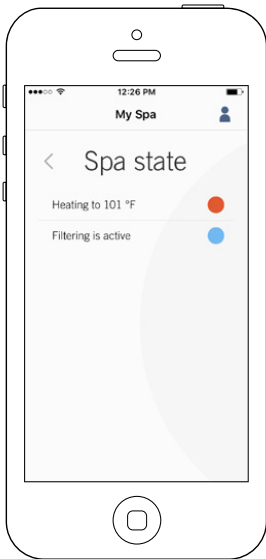

This page displays all the active states of your spa. Below is a quick description of each state you may encounter on your spa. Each state is associated to a priority and color that determines the color of the widget on the home page.

- Indicates that there is an error on your spa.
- Indicates that there is presently an active user demand on your spa (ie. pump, blower or light is on).
- Indicates that your spa is now heating to your set point.
- Indicates that your spa is now in a filtering cycle.
- Indicates that your spa is now in economy mode.
- Indicates that your spa is running normally (there is no user demand, heating, no filtration or economy active).

The widget on the home page displays a single color at a time. The color displayed is decided by priority of state. The established priority is as listed above.

Change temperature

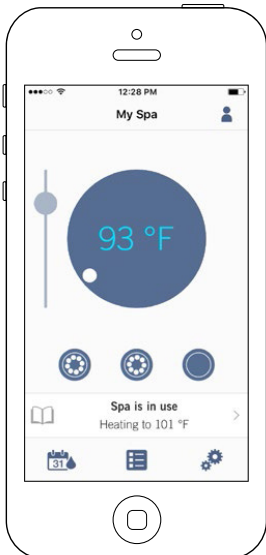

Touch the centered widget to reveal the temperature control bar.

Use the slider on the control bar to change your spa's temperature* set point.

** If you are in economy mode your spa temperature will be 20°F below your set point.*

Turn on/off accessories



According to your spa pack configuration, you can start or stop an accessory by simply touching the associated icon. The icon will become animated when the accessory is on. Simply press on the icon to start or stop the accessory.

If your accessory has more than one speed, press the button until the desired speed is reached.

The icon designs are customized according to your spa pack configuration:

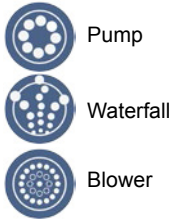

Turn on/off the lights

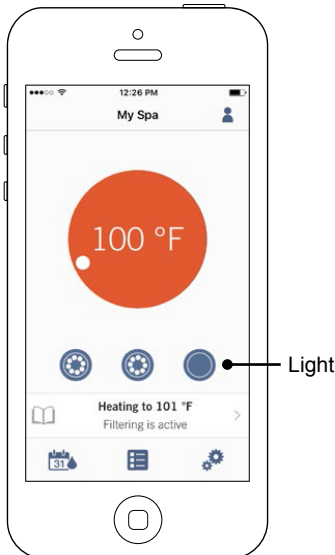

To control your spa lights, simply press the button to turn it on or off

Control your in.mix 300

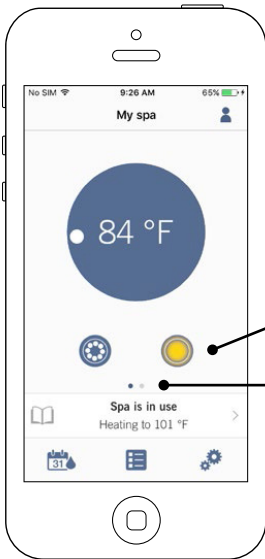

This menu is only available if an in.mix 300 is detected in your spa accessories

To turn on or off the in.mix 300, you can use, if you want, the light icon on your home page. To go to your in.mix 300 page, simply swap to the left.

Turn on/off in.mix 300

Swap to in.mix 300

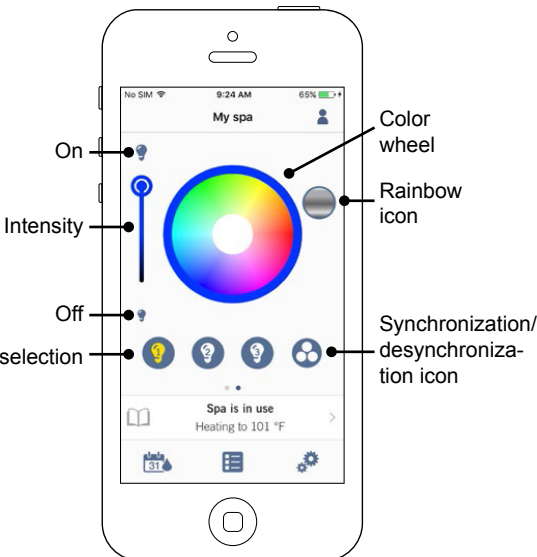

The in.mix 300 page allows you to customize your color zones in or around your spa.

The light bulb icons allow you to turn on and off your in.mix 300.

To select a zone, click on the wanted one in the “zone selection” stripe. To change the color, use the color wheel to choose the one you want. On the left side, the intensity slider allows you to modify the brightness of your lights. Use the rainbow icon to get color gradation.

The synchronization / desynchronization icon gives you the possibility to match the color of the selected zone with the other zones

Water Care

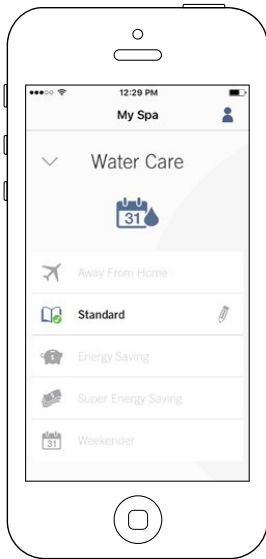

The Water Care page will help you set up your ideal filtration and heating settings. Choose between Away from Home, Beginner, Energy Savings, Super Energy and Weekender, depending on your need. Touch the Water Care name you would like to activate, a green checkmark will appear on the icon, indicating you have selected it.

By default, each Water Care mode has pre-configured schedules of economy and filtration. To modify Water Care options, touch the pencil icon at the right end of the desired Water Care to open its menu.

Below you have a short description of each Water Care at default state:



Away From Home:

In this mode the spa will always be in economy; the set point will be reduced by 20° F.



Beginner / Standard:

The spa will never be in economy mode and will be filtering according to the pack's low level configuration.



Energy Savings:

The spa will be in economy mode during the peak hours of the day and resume normal mode on the weekend.



Super Energy Savings:

The spa will always be in economy mode during peak hours, every day of the week.



Weekender:

The spa will be in economy mode from Monday to Friday, and will run normally on the weekend.

Reminders

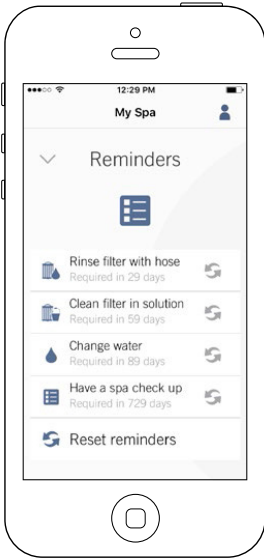

Reminders page will help you to make a follow-up of your maintenance.

The in.touch 2 will remember you to perform required maintenance tasks on your spa, such as rinse filter or clean filter. Each task has its own reminder duration based on normal use. The owner can reset his reminders after the spa maintenance.

Modifying schedules

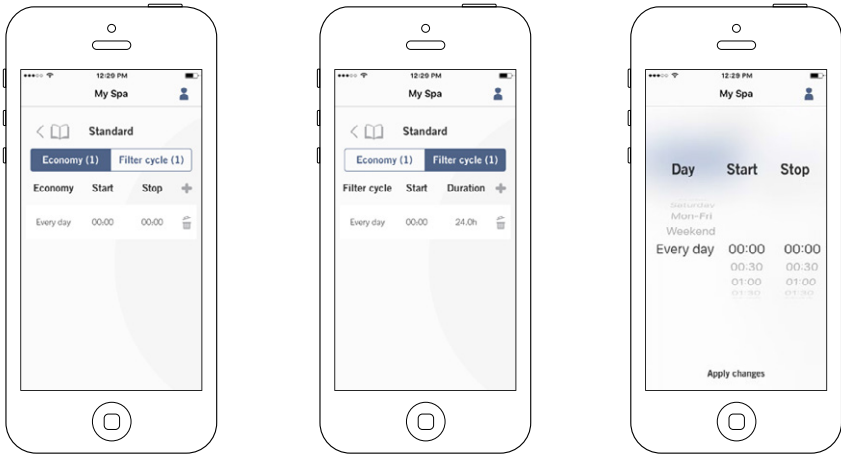

In this menu it is possible to add, remove or edit schedules of economy or filtration.

To have access to this menu, simply touch the tabs:
 Water Care menu - the little pen at the right of the wanted water care

Touch the Economy tab to modify the economy schedules and Filter cycle tab for the filtration schedules. You can add economy or filtration schedules by touching the « + » symbol.

To delete a schedule, touch the garbage can icon at the right end of the desired line.

You can modify the programmed schedules by selecting one and adjusting the schedule.

You have several possibilities for the schedule (Mon-Fri, weekend, every day, or single days). The schedules will be repeated weekly. The time and duration are set in 30 minute increments. Once you have set the schedule, use the arrow at the top of the page to go back. Ensure that you have selected the desired Water Care mode in the main Water Care menu.

When an economy schedule is active, the set point will be reduced by 20°F, which means that the heating system will not be engaged unless the temperature falls to 20°F below the spa's set temperature.

The filtration schedule is applied to the main filtration pump, most likely pump 1. If your spa uses a circulation pump configured to run 24 hours, the screen will show purge schedules instead of filtration. The purges are pre-programmed for a fixed number of minutes, therefore the duration will be set to N/A on the screen and only the start time can be modified.

Spa Settings

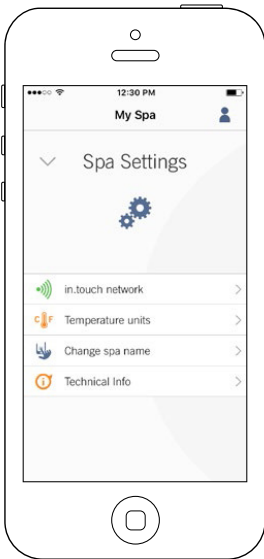

In the Settings page you can access the following:

- *in.touch network*
- *Temperature units*
- *Change spa name*
- *Technical info*

To select an item, tap on the arrow next to it. It will open the selected menu.

in.touch network

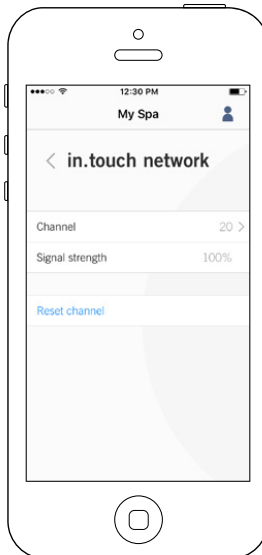
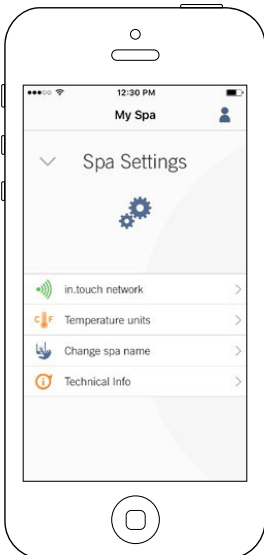

The in.touch network menu allows you to have access to information concerning the RF connection parameters between the Home Transmitter and the Spa Transmitter. This menu gives you access to:

- Channel
- Signal strength
- Reset channel (resets channel to ... default)

To change channels, press on the Channel line.

Change channel

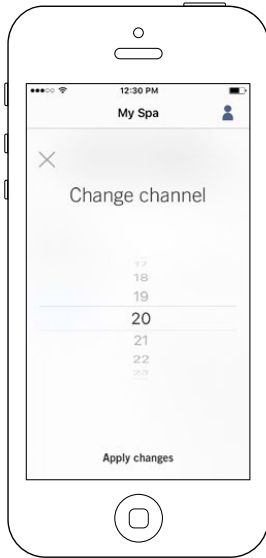

The Change channel page allows you to change the channel used by the two in.touch 2 modules.

In some cases, this can help you to have a stronger signal.

You can have access to this page by touching the following tabs: Spa settings (at the bottom right) - in.touch network - channel

Temperature units

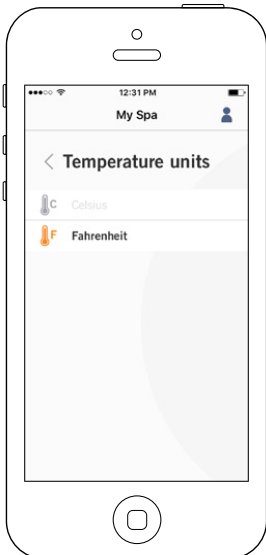

This menu lets you change the units used to display temperature.

You can have access to this page by touching the following tabs: Spa settings (at the bottom right) - temperature units.

Name

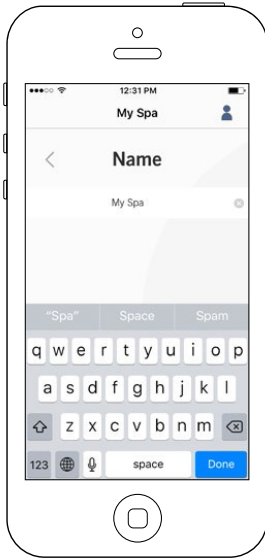

This section allows you to edit the name of the spa.

You can have access to this page by touching the following tabs: Spa settings (at the bottom right) - Change spa name

Technical Info



This section shows information about the in.touch 2 software number and the revision numbers of the different components of your system.

You can have access to this page by touching the following tabs: Spa settings (at the bottom right) - Technical info

Settings

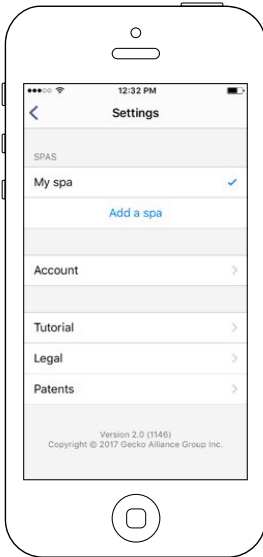

In the Settings page you can access the following:

- *Add a spa from local network*
- *Account*
- *Tutorial*
- **Legal*
- ***Patents*

To select an item, tap on the arrow next to it. It will open the selected menu.

*The button Legal will bring you to this web site :
<https://geckointouch.com/legal>

**The button Patents will bring you to this web site:
<http://geckoportal.com/corpo/#patents>

Add a spa

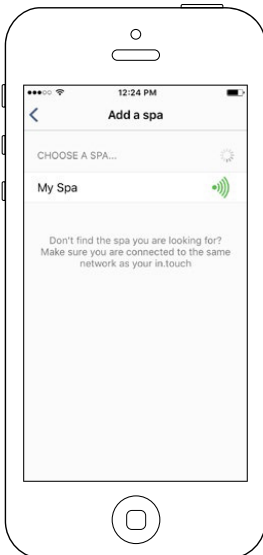

This page displays all the spas detected by your application.





To detect your spa, you need to connect your mobile device to the same network to which you connected your Home Transmitter.

Once you have done a connection with the spa its name will be saved on this page to allow you to connect to this spa from anywhere.

You can have access to this page by touching the following tabs: Settings (up right corner) - Add a spa

The RF signal strength (communication between the two in.touch 2 transmitters) is illustrated on the Select a spa page.

There are 5 possible states:

-  Signal superior to 80%
-  Signal between 80% and 51%
-  Signal between 50% and 31%
-  Signal below 30%
-  The Spa Transmitter is not available

Account

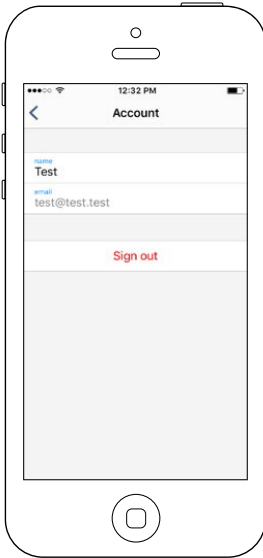

This section gives you access to your account information.

You can have access to this page by touching the following tabs:
Settings (up right corner) - account

Tutorial

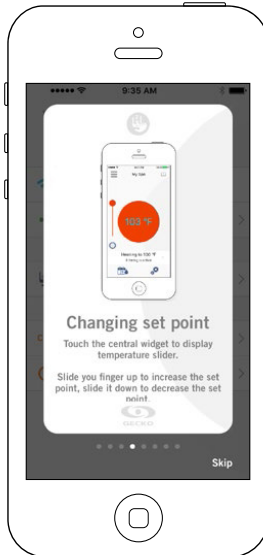
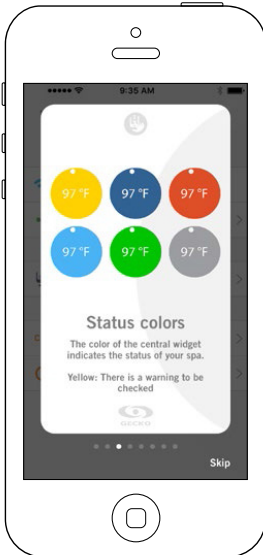

This section gives you a quick overview of your in.touch 2 application's functions.

Technical Support invitation

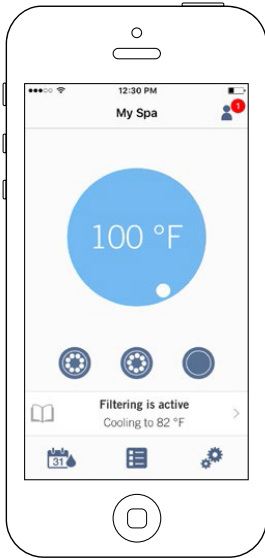

When you receive an invitation for Technical Support, a red circle will be displayed next to the “setting” logo (top right corner).

Authorizing an invitation

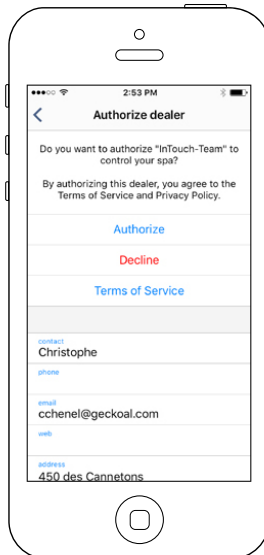
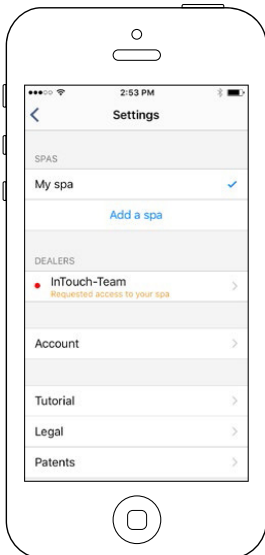

All the invitations you may receive are under the dealers tab in the “settings” menu.

To choose an invitation, simply click on it. You will then see a window authorization to confirm with the dealer's information.

You can also decline the invitation at any time if you want to.

Dealer page



Once you've had a dealer on your in.touch 2 app, you can, at all times, have access to his information.

If you don't want your dealer to have access to your spa anymore, simply swap to the left the "Allow access to your spa" button at bottom of the page.

Both in.touch 2 modules have a status LED to help diagnose problems, if any occur.

Troubleshooting

There are 2 different modules in the in.touch 2 kit: The Home Transmitter (EN Module) and the Spa Transmitter (CO Module). They communicate together via an RF link. The Home Transmitter is responsible for the Ethernet communications and the Spa Transmitter is responsible for the spa communications.

OPTIONAL ACCESSORIES - CHEMICAL TREATMENT

CHEMICAL TREATMENT DEVICE



THINGS TO KNOW ABOUT THE ASIN AQUA

The CHEMICAL TREATMENT device provides pure sparkling water that contains only a minimal amount of chemical substances. This system directly measures and monitors free chlorine content and the redox potential of the spa water. The CHEMICAL TREATMENT device regulates the spa water while using only a minimal amount of chlorine, thus eliminating the strong smell of overtreated water. The touch screen solution allows you to attentively monitor the measuring units and regulations of your spa. The CHEMICAL TREATMENT device uses the current filtration equipment of the spa and works with a timed dosing system and even with chlorine-free oxygen based disinfection.

HEALTH AND SAFETY

The CHEMICAL TREATMENT device makes it possible to adhere to the rules of hygiene in regards to the physical and chemical demands concerning the spa water's quality. Do not open the casing of the CHEMICAL TREATMENT device and do not change any of its internal parts. Opening the casing voids the warranty. The chemicals used by the CHEMICAL TREATMENT device can only be used in safe conditions to avoid damage or personal injury. Always use personal protective equipment (safety goggles and gloves) when handling pH or chlorine substances. For further information consult your Chemical Safety Data Sheet.

INSTALLING THE CHEMICAL TREATMENT DEVICE

Install the CHEMICAL TREATMENT device in an environment free of dust and high humidity. Secure your device on the wall in a way that leaves at least 30cm of empty space on either side.

To connect your CHEMICAL TREATMENT device to the water supply provides a special Speedfit quick connector. To connect push the plastic pipe into the Speedfit quick connector. To remove the pipe from the quick connector push in the collet and pull the pipe out.

1. Cut off the plastic pipe at a 90-degree angle to ensure proper connection. Use a sharp knife or blade for precise cutting.
2. Connect the water intake on the left and the water outlet on the right. Ensure that the water pressure does not go over the 1,5 bar value.

3. The water outlet of the CHEMICAL TREATMENT device can be connected to the plumbing, before the pump, to the skimmer, the buffer tank, or the drain pipe.

DISCONNECTING

After connecting to the water supply your ASIN Aqua device is able to take samples of the spa water and analyze them. Analysis makes monitoring of chlorine levels and pH values possible, ensuring the spa's hygiene.

Adjusting the spa's parameters Every spa represents a unique solution. Temperature, size, location, and water hardness all affect the ability of the CHEMICAL TREATMENT device to monitor and regulate the water of your spa. To reach maximal performance the CHEMICAL TREATMENT device must be adjusted to your spa's characteristics. After selecting the REQUIRED VALUES menu item:

1. Adjust the filtration parameters of the spa.
2. Adjust the parameters of the water. Adjusting the filtration parameters The CHEMICAL TREATMENT device must know the spa's size and filtration cycles. When installing the CHEMICAL TREATMENT device you must define these spa parameters:
 - A.) Choose the SETTINGS menu item on the start screen, then press the PARAMETERS item to get to the next screen.
 - B.) Choose the spa PARAMETERS item
 - C.) Choose the spa VOLUME menu item.

Your choice is shown by a black triangle. Check the spa's data sheet for its volume. (1000L = 1m³) Press the + and - buttons to enter the appropriate spa value, then press OK to save.

Note: If the volume of your spa is between 1000 and 1500 liters, select 1 m³. If it is between 1500 and 2000 liters, select 2 m³.

- D.) Choose the desired disinfection timeframe and press OK to save. Your choice is shown by a black triangle at the bottom. The displayed number shows the timeframe of the disinfection cycle, not its frequency.

OPTIONAL ACCESSORIES - CHEMICAL TREATMENT

SUGGESTION:

The recommended filtration timeframe is 24 hours. The minimal filtration timeframe is 6 hours.

After selecting the spa filtration parameters for the CHEMICAL TREATMENT device adjust the parameters of the water as well. The spa filtration and water parameters determine what settings the CHEMICAL TREATMENT device will use for correct monitoring and regulation of the spa.

If you change the mass of the water of the filtration timeframe of the spa, you must update the parameters.

- Depth
- Length
- Width

USER GUIDE FOR THE CHEMICAL TREATMENT DEVICE

Setting the parameters of the water

The parameters of the water settings define the attributes of the spa water for the CHEMICAL TREATMENT device. The CHEMICAL TREATMENT device also contains presets based on the following conditions:

- Indoor or outdoor spa.
- The level of water hardness.
- The average water temperature.

Because each of these parameters affect the operation of the CHEMICAL TREATMENT device, appropriate parameters of the water must be defined to ensure optimal performance of the CHEMICAL TREATMENT device in your spa. Set water parameters when installing CHEMICAL TREATMENT DEVICE.

1. In the main menu select SETTINGS, then PARAMETERS, then select the spa PARAMETERS menu item to enter the next screen.
2. SPA Select your spa type using the checkboxes.
 - INDOOR
 - OUTDOOR
 - EXTREME CONDITIONS

3. AVERAGE TEMPERATURE
Select the average temperature of the spa.

WARNING! This parameter affects the maximum hours duration of the disinfection process.

4. WATER HARDNESS:
Enter the water hardness level of the spa. The unit of measurement is dH (degrees of hardness) and can be 0 - 9 soft, 9 - 21 hard, and 21+ extra hard.

Before calibrating the CHEMICAL TREATMENT device ensure that the parameters entered match the properties of the spa.

ⓄpH settings

Setting the desired values:

1. In the main menu select SETTINGS, then the PARAMETERS menu item.
2. Select the blue pH button on the right.
3. Adjust the pH value using the - and + buttons.

CALIBRATING THE pH PROBE OF THE CHEMICAL TREATMENT DEVICE:

1. Check the pH value of your spa manually.
Use an Aseko tester.

Displayed value

- 6,8
- 6,8
- 7,0
- 6,8
- 6,4

SUGGESTION:

We recommend a pH value of between 6.5 and 7.6.

- Use a low pH value if the spa is cleaned via active oxygen system.
 - Use a high pH value if the spa is cleaned via saltwater electrolysis system.
 - Use a pH value of 7.0 if the spa is cleaned via chlorine.
2. In the main menu of the CHEMICAL TREATMENT device select SETTINGS, then the CALIBRATION menu item.
 3. Select the blue pH button on the right.
 4. Compare the data shown by the CHEMICAL TREATMENT device with the results of the manual measurement.
If there is a difference, adjust the values shown by the CHEMICAL TREATMENT device with the + and - buttons until they match the manual results, then select OK to save.

If the results of the manual test fall outside the 6.2 - 7.8 range, you will receive the following notification.

If the difference between the results of the manual test and the values shown electrically by the pH valve is greater than 0.3, you will receive the following notification.

pH buffer 7.00 #12065

SUGGESTION:

To finely calibrate use the 7.00 pH testbuffer.
User guide for the ASIN Aqua device.

Choose the function of your CHEMICAL TREATMENT device:

1. Free chlorine probe CLF
2. Redox electrode probe RX
3. Dosage based on time ml/m3 per hour or per day

In the main menu select SETTINGS, then the TYPE OF PROBE to enter the next screen.

If you have a free chlorine probe:

Your CHEMICAL TREATMENT device is set up and connected to the spa water and the chemicals.

Adjust the chlorine level to 0.0 mg/l.

Adjust the pH value to 7.0.

Manually adjust the chlorine level of your spa to between 0.5 and 1.2 mg/l via the manual dispenser of the ASIN Aqua or directly via the manual dispenser of your chlorine disinfectant. Wait 24 hours for stabilization.

OPTIONAL ACCESSORIES - CHEMICAL TREATMENT

THE FIRST CLF CALIBRATION

Using the provided Aseko test kit to manually check the chlorine level of your spa by taking a sample from the output stream of spa water.

In the main menu of the CHEMICAL TREATMENT device select SETTINGS, then the CALIBRATION menu item.

Select the yellow chlorine box on the left of the screen. If the probe is broken or has any other malfunction, you will receive the following notification.

Compare the data shown by the CHEMICAL TREATMENT device with the results of the manual measurement. If there is a difference, adjust the values shown by the CHEMICAL TREATMENT device with the + and - buttons until they match the manual results, then select OK to save.

If the chlorine level data of the manual test matches the readings of the CHEMICAL TREATMENT device, your probe measures chlorine level accurately.

SUGGESTION:

Measure the chlorine level of your spa weekly.

SAFETY FUNCTIONS:

The CHEMICAL TREATMENT device has safety functions that prohibit overdosage of the spa. The device uses the following safety functions:

- Maximal safety dosage
- Overly fast change in the pH value
- Dosing without probe reading

If you adjust the parameters of the water appropriately, the CHEMICAL TREATMENT device calculates the maximum hourly dosage of the disinfectant. Thanks to this function overdosage is highly improbable.

The maximal safety dosage moves between 1 and 11 ml/m³/hour. In extreme conditions the value rises to 25 ml/m³/hour.

Overly fast change in the pH value

can be caused by heavy rain, adding large amounts of water, or inordinate usage. If any of these occur the CHEMICAL TREATMENT device shuts down dosage of the pH medium for 2 hours and only restarts it when the pH value stabilizes. Change in the pH value without a probe reading.

Depending on the water hardness the CHEMICAL TREATMENT device reports an error and shuts down dosage of the pH agent.

- From soft to moderately hard < 9°dH.
If there is no change in the pH value, the ASIN Aqua device shuts down dosage of the pH agent after 10 doses.
- Hard 9–21°dH.
If there is no change in the pH value, the ASIN Aqua device shuts down dosage of the pH agent after 15 doses.
- Extra hard > 21,01°dH.
If there is no change in the pH value, the ASIN Aqua device shuts down dosage of the pH agent after 25 doses.

WARNING! Never mix the pH agent with a chlorinated substance. Always prevent mixing of the pH agent with a chlorinated substance by rinsing whenever you are performing maintenance on the plastic cleaning pipes or valves.

WARNING! Always ensure that the spa water is chemically clean and uncontaminated before setting up your CHEMICAL TREATMENT device.

When setting up the CHEMICAL TREATMENT device ensure that it is no more than 8 meters far from the point where the chemicals connect to the spa's water supply.

When setting up the ASIN Aqua device ensure that there are no more than 2 vertical meters between the wall mount and the point where the chemicals connect to the spa's water supply.

WARNING! Usage of pliers and wrenches damages the tube and causes fitting problems.

WARNING! This parameter affects the maximum hours duration of the disinfection process.

WARNING! The filtration time frame should be set as the daily operating time of the CHEMICAL TREATMENT device.

WARNING! This parameter affects the maximum hours duration of the disinfection process.

WARNING! These parameters affect the maximum hours duration of the disinfection process.

pH CALIBRATION

WARNING! Probes do NOT require calibration most of the time. We authenticate the pH probe of the CHEMICAL TREATMENT device at the factory.

If you do not let the probes stabilize in the water before the calibration and usage of the system, we cannot guarantee proper function of the CHEMICAL TREATMENT device. Check the pH calibration once a year and change the probe if needed.

OPTIONAL ACCESSORIES - SAND FILTER SYSTEM

SAND FILTER SYSTEM

ACCESSORIES OF THE SAND FILTRATION SYSTEM:

- filter tank
- prefilter circulation engine
- circulation valve
- silica sand, 0.7 - 1.2 particle size

Operational concept: the water is transported by a circulation engine through a filter housing (which does not contain a filter cartridge), then it passes through the sand filter. Then the filtered water flows through the circulation valve and back to the spa. In this case the circulation valve is set to "filtration". Upon inspecting the sand filter's filling you may come across the following issues.

The sand is white when dry: this points to the presence of limescale, in which case there are 2 ways to proceed. Changing the filter sand or applying disinfectant. The sand feels greasy to touch and forms lumps. Take a handful of sand and rub it in your palm. If your skin feels greasy, a layer of biofilm has formed around the sand. The formation of a biofilm layer is often related to lack of rinsing. The actual filter here is the silica sand through which the water passes in a downward flow and the sand filters the particles floating in it. The particle size of the sand (0.7 - 1.2mm) is an important regulation. Part of the sand filtration system is the circulation valve which, depending on its position in relation to the tank, can be a side- or a top valve. The lever on the circulation valve can be used to switch between functions. The sand filter has to be backwashed weekly, since pollution can back up in the sand and obstruct the flow of the water. During backwashing the water flow in the filter is reversed, so any filtered pollution will wash down the drain.

We recommend changing the sand filter every 2 - 3 years.

We recommend disinfecting the sand twice every year. This process involves treating the sand with anti-algae chemicals diluted in water.

LOADING THE SAND FILTER

1. Before loading the sand into the filter put up the filter tank and fasten the pipe links.
2. Remove the lid and seal.
3. Fill the filter with the required amount of sand.
4. Clean the seal's nest on the lid.
5. Put the lid on and tighten it.

FUNCTIONS OF THE CIRCULATION VALVE:

- filtration
- backwashing, rinsing
- postwashing, postrinsing
- flushing
- circulation
- locking

INSTALLATION

After filling the sand filtration tank with sand wash the sand as follows:

1. Set the valve to "RINSE".
2. Open the lockings so that the water flow will not be obstructed and switch on the pump for 3 minutes.
3. Switch the pump off and set the valve to "FILTRATION". After you finish these steps the sand filtration system is ready to filter the spa water.

Attention: operate the valve only when the pump is switched off.

FILTRATION

While the pump is switched off set the valve to "FILTRATION". Switch the pump on.

While the pump is on occasionally check the pressure gauge to monitor the fullness of the filter. When the pressure reaches 1.3 kg/cm², perform "RINSING".

RINSING

Every load of sand represents thousands of channels meant to tackle floating particles and keep them within the sand filter, which means that the channels open to water flow are gradually reduced in number. Because of this the pressure within the filter progressively builds up to 1.3 kg/cm². This means that the sand filter is not capable of retaining any more contaminations and cleaning is necessary. Do this as follows. Switch the valve to "RINSING" while the part leading to the drain is open and turn the pump on. Any contamination will flow down the drain.

CIRCULATION

At this setting of the valve the pump moves the water directly into the spa without it going through the sand filter.

POSTRINSING

After rinsing the filter and after setting the device to "FILTRATION" the water will be turbid for a few seconds. To avoid mixing the turbid water with the spa water set the valve to "POSTRINSING". This should be done as follows. Set the valve to "AFTER-RINSING" right after "RINSING" and switch the pump on for max. 1 minute. This setting will pump the filtered water right down the drain.

FLUSHING

If the spa cannot be emptied directly into the drain because there is no drainage at the level of the bottom of the spa, flushing can be performed via the filtration pump. To perform flushing set the valve to "FLUSHING". While the valve of the bottom drainage is open, switch the pump on.

Important: ensure that while the pump is switched on the hair filter and full tubing of the bottom drainage is always full of water.

CLOSED

The water flow from the sand filter to the pump is closed in order for the basket of the pump to always be possible to be opened.

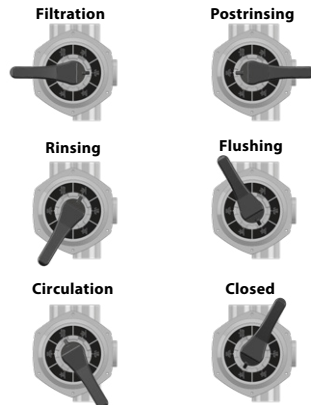

WATER TREATMENT BASICS

WATER TREATMENT BASICS

The chemical equilibrium of the water

The spa water will be clean and clear if its chemical components are in equilibrium.

1. pH value:

The first important indicator is the pH value of the water. pH is measured on a scale of 0-14 where 7 is the neutral value. The ideal value is between 7.2 and 7.8 pH. pH values out of this range may irritate the skin.

Under this value the water is acidic, above is basic. The pH value of the human eye is around 7.5, below 7.2 and above 7.8 the water will sting the eyes. Most problems are caused by the pH value being too high. An improper value reduces the effect of the disinfectant.

A high pH value can cause the following problems:

- The disinfectant can be ineffective.
- The solution can exude solid matter.
- The water can become turbid.
- Can cause skin irritation.

A low pH value can cause the following problems:

- The water can become turbid.
- Can cause eye irritation.

Rain or adding fresh water will change the pH value of the water.

2. Disinfection:

Disinfectant is the chemical that eliminates or neutralises the microorganisms (bacteria, algae, fungi, viruses) present in the water. Microorganisms are small microscopic organisms which cannot be detected by the naked eye and are continuously getting into the water through rain, wind, and the bodies of the bathers. If they are not eliminated, they pass from one person to the other through the water (and may cause sickness, infection). Organic matter turns the spa water opaque and cloudy.

As we are dealing with warm water spas, bromine or active oxygen is most often used.

3. Preventing growth of algae:

In addition to the disinfection of water the prevention of growth of algae is another key issue. Algae can grow even if proper disinfection and filtration is performed.

Antialgae treatments only work with appropriate pH values.

4. Water hardness:

Water hardness is determined by the quantity of calcium and magnesium salts dissolved in the water. Hard waters contain too much of these dissolved salts and thus scale will form if left alone. Scale can cause significant damage to the walls of the spa, piping, filter, heating, and engineering units. In Hungary water is medium hard. Water hardness cannot be reduced by the addition of chemicals, but formation of scale can be prevented.

5. Frothing:

Froth is the smaller-bigger agglomeration of the bubbles and colloid contaminants found on the surface of the water. It is mostly caused by mixing of dirt, cosmetics, body lotions, etc. that soak out of the human skin and the chemicals. It endangers conservation of the aesthetic appearance and cleanliness of the water.

6. Water analysers:

There are several types of water analysers which are mostly used to measure chemical and disinfectant effect. Chemical (pH); Disinfectant (Br, O₃)

To preserve the condition of the pool, we recommend the use of Wellis chemicals or a product with the same active ingredient. This will not only make your pool last longer, but you can enjoy your free time in safe, clean water that's crystal clear.

Tester types:

Box containing tablets and graduated measuring glass.

Litmus paper indicators in a box.

Chemicals should always be loaded into the filter housing.

Then proper disinfection of the spa balance if the

chemical levels are not at least 48 hours below the specified value.

Even with the most accurate disinfection after 2-3 months the water quality is no longer maintainable and it is necessary to replace the entire water quantity. In this case we advise you an extensive shock-like disinfection with algae. Dissolve a tablespoonful of algae in the spa water and run the engines for 15 minutes. After switching it off for 5 minutes switch it on for another 1-2 minutes, then drain, clean, and rinse the spa.

ATTENTION!

Using alcohol- or acetate based cleaning products for cleaning the spa is PROHIBITED!

To preserve the condition of the pool, we recommend the use of Wellis chemicals or a product with the same active ingredient. This will not only make your pool last longer, but you can enjoy your free time in safe, clean water that's crystal clear.

The manufacturer is not responsible for damage resulting from the use of such chemicals.

The chemical treatment of the water should only be done by persons under 18 years of age under parental supervision.

Maintenance should only be performed by qualified professionals.

SPA MAINTENANCE

Do not expose the spa to sunlight! Without a thermal cover direct exposure to sunlight can cause discoloration in the water. Use a spa cover when you are not using the spa, whether it is filled with water or not. Do not expose the spa to rain or snow. If possible, build a covering shelter for the spa.

The side coating of the spa should be protected from high UV exposure (e.g. SPA BAG) and cedar spas should be periodically treated with UV-resistant products. The coating is lined with UV-resistant paint, but because of the previously mentioned factors there is no guarantee that it will prevent fading of color. With cedar coated spas wood treatment is recommended yearly.

1. Periodically drain, clean, and refill the spa. We recommend utilizing professional service for the refill.
2. Clean the filter once a month.
3. Shower before stepping into the spa.

Maintenance is recommended in the following periods:

- Weekly and before every use Check the spa water - see the basics of water treatment
- Every 3 months
- Change the filter cartridges
- Every 3 months Change the spa water - see draining the water
- Yearly Inspection of the spa is recommended - call a professional for proper inspection.

MAINTENANCE

FILTER CARTRIDGE REMOVAL AND CLEANING

Cleaning mechanical contaminations via continuous water circulation and chemical mixture is a basic requirement for proper cleaning of the spa water. Every spa has an engine designed for this purpose. The circulation engine circulates the water through the filter(s). The filter protects against contamination floating in the water.

Cleaning of the filter cartridges is recommended weekly.

Soaking the filter cartridges in water mixed with chlorine or antialgae agents for 24 hours is recommended monthly.

Changing the filter cartridges is necessary every 3 months.

SURFACE MAINTENANCE

Wipe the surface with a wet cloth. Always use a neutral cleaning product and a soft wiping cloth. Never scratch the acrylic surface with an abrasive tool, blade, or knife, because it may cause damage. Never use nail polish remover, acetone, or paint stripper when cleaning the surface because it may cause damage.

Maintenance manual for the control panel of the spa:

- Do not damage the control panel with anything hard. If possible,
- Avoid exposing the control panel to direct sunlight.
- When not using the spa, always use a spa cover.

WINTERIZATION

Remember to correctly maintain the spa if you are not using it in the winter. If you are not using your spa during the winter months and want to put it out of service properly, call one of our qualified professionals to winterize your spa at a prearranged date and time.

The winterization encompasses the following:

- Drainage of used water
- Cleaning of the inner surface of the spa
- Dewatering of pipe and jet system
- Dewatering and disconnecting the engine's interface
- Delivery - reception

If the spa is not winterized properly, the system can retain water that can easily freeze during the winter months. This can cause heavy irreparable damage to the pipes and the engine. This will void the warranty.

Maintenance of the out-of-service spa:

When you are not using the spa, use the thermo cover and fasten it with the buckles. Do not forget! If the spa is filled with water and you are not using it, lift the cover at least once a week to ensure proper ventilation. The thermo cover is multipurpose. Most importantly it decreases the heating time of the water to operational temperature and decreases the energy needed to maintain water temperature, decreasing the operational costs.

Using the cover you can avoid leaves, rain, snow, or other contamination entering the spa water, effectively sealing it off from environmental effects.

Fastening the cover with buckles prevents young children from using it without parental supervision.

CLEAN THE FILTER CARTRIDGES WEEKLY AS FOLLOWS:

WARNING!

Changing the filter cartridges is recommended every 3 months!

Operating the spa without a filter cartridge is PROHIBITED

1. Remove the lid of the filter.
2. Take out the filter cartridge.
3. Clean contamination from the cartridge with water.
4. Soak the cartridge in lukewarm water mixed with chlorine or antialgae agents for 1-2 hours, then rinse it.

Never use an alkaline detergent or a high-pressure cleaner to clean the filter!



DRAINING THE WATER

You can drain the water via the drain outlet in accordance with environmental standards.

1. Find the drainage and remove the cap.
2. Screw on the metric intermediate piece that came with the spa.
3. Twist the larger receiving part anticlockwise as much as possible.
4. Pull the receiving part towards you - the water will start flowing from the spa.
5. After the water has drained from the spa go through the previous steps in a reversed order.

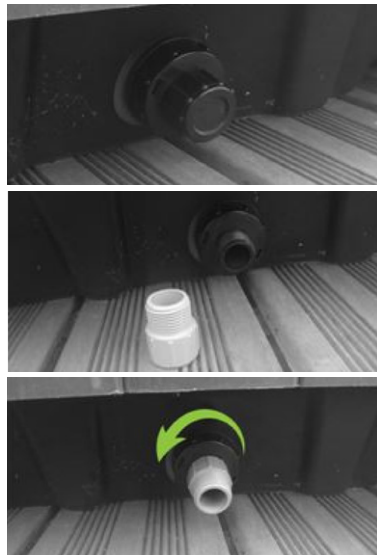

WIRING DIAGRAM - W2000

W2000



OVERVIEW

Probe connectors
(heat.wav's low voltage
cable or regulation probe
and overhear captor
model-re)

Light output (12 VDC)

Communication link
(in.touch or in.stik)

Main keypad
connector

Power output drivers

Pump 1 and
accessory fuse

heat.wav power con-
nection

Bonding lugs

Main power entry
connection

Watertight strain
relief system

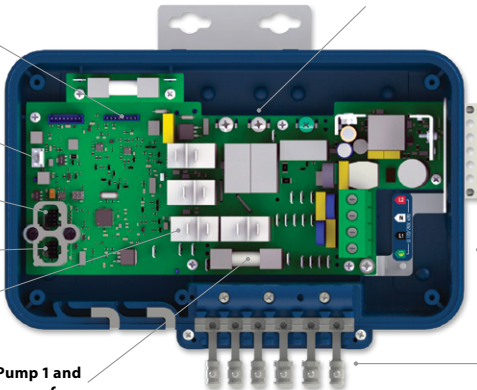

WIRING DIAGRAM - W2000

CONNECTIONS

CONNECTING HIGH VOLTAGE ACCESSORIES: EUROPEAN, AUSTRALIAN, NEW ZEALAND MODEL W2000

These tabs require high-voltage accessories to have straight, non-insulated, female quick-connect terminals for all connections, including ground. Refer to the following tables for correct connections. Note that all female terminals must be correctly and completely seated on the PCB tab for proper current ratings.

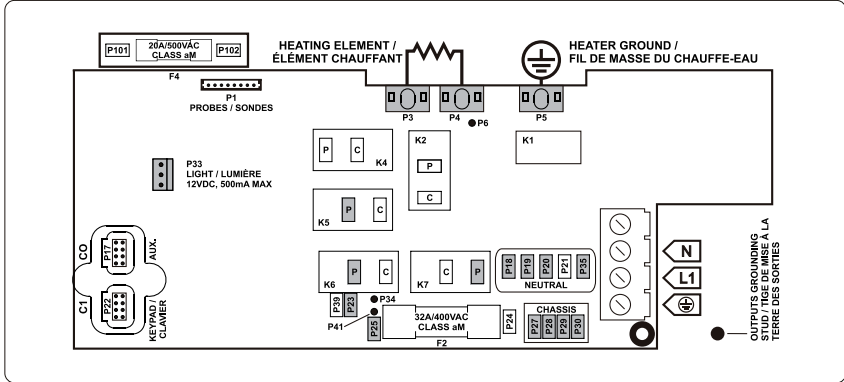

Make sure all accessories are linked to the bonding lug connector located on the side of the spa pack.

DIRECT OUTPUT

Voltage	230 V
Ground	P27
Line	P25
Common	P18

PUMP 1

Voltage	230 V
Ground	P28
Low speed	K6-P
High speed	K7-P
Common	P19

OZONE

(Working with pump
1 low speed)

Voltage	230 V
Ground	P30
Line	P23
Common	P35

HEAT.WAV-YJ

Green / ground	P5
Black / line	P3
White / common	P4

LIGHT

(12 V DC , 500mA)

Switch	P33
--------	-----

WIRING DIAGRAM - W2000

ELECTRICAL WIRING

ELECTRICAL WIRING: CE/AUS/NZS MODELS

Refer to wiring diagram in the enclosure box lid for more information.



WARNING!

W2000 models must always be connected to a circuit protected by a Residual-Current Device (RCD) having a rated operating residual-current not exceeding 30 mA.

Correct wiring of the electrical service box, RCD, and pack terminal block is essential! Check your electrical code for local regulations. Only copper wire should be used, never aluminum.

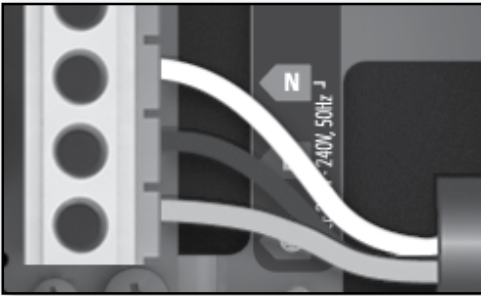

230 V (3 WIRES)

Insert each wire into the appropriate socket of the main entry terminal block according to the color code indicated on the sticker. Use a flat screwdriver to tighten the screws on the terminal.

After making sure wires are securely connected, push them back into the box and replace the cover. Do not over tighten cover screws (torque to 8 in.lb max {0.9 N.m.}).

Connect the bonding conductor to the bonding lug on the side of the spa pack (a grounded electrode conductor should be used to connect the equipment grounding conductors).

WIRING DIAGRAM - W3000 & W5000

W3000 & W5000



WIRING DIAGRAM - W3000 & W5000

CONNECTIONS

CONNECTION HIGH VOLTAGE ACCESSORIES: W5000 (EUROPEAN)

These tabs require high-voltage accessories to have straight, non-insulated, female quick-connect terminals for all connections, including ground. On -ce packs, only 230V accessories are supported. Refer to the following tables for correct connections. Note that all female terminals must be correctly and completely seated on the PCB tab for proper current ratings.

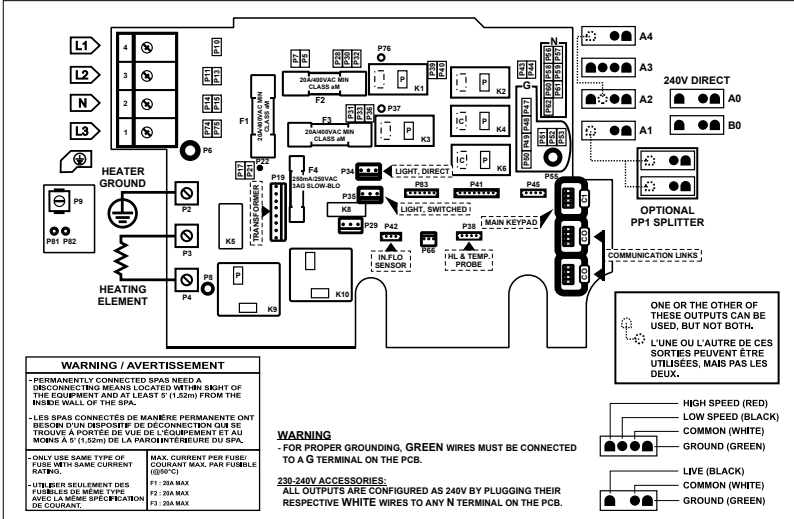

DIRECT OUTPUT 1

(Floating connector)

Voltage	230 V
Green / ground	P47
Black / line	P32
White / common	P56

PUMP 1 (A3)

Voltage	230 V
Green / ground	P49
Black / low speed	K2-P
Red / high-speed	K1-P
White / common	P59

BLOWER / CP /

ABG* (A4)	230 V
Voltage	230 V
Green / ground	P48
Black / low speed	K6-P
White / common	P57

OZONATOR / PUMP 3 /

CP (A1)	230 V
Voltage	230 V
Green / ground	P52
Black / line	K4-P
White / common	P62

PUMP 2 (A2)

Voltage	230 V
Green / ground	P51
Black / low speed	K6-P
Red / high-speed	K3-P
White / common	P60

CIRC. PUMP** (A1)

Voltage	230 V
Green / ground	P52
Black / line	K4-P
White / common	P62

OZONATOR / CP (B0)

(Floating connector)

Voltage	230 V
Green / ground	P48
Black / line	K2-P
White / common	P57

LIGHT (12 V AC, 1A MAX.)

Voltage	
Always on	P34
Relay	P35

* ABG: Auxiliary Bubble Generator

** Ozonator and circ pump can be combined on the same output via the optional splitter PP1.

This table shows typical connections. OEMs may have a different connection scheme.

WIRING DIAGRAM - W3000 & W5000

CONNECTIONS

CONNECTION HIGH VOLTAGE ACCESSORIES: W3000 (EUROPEAN)

These tabs require high-voltage accessories to have straight, non-insulated, female quick-connect terminals for all connections, including ground. On -ce packs, only 230V accessories are supported. Refer to the following tables for correct connections. Note that all female terminals must be correctly and completely seated on the PCB tab for proper current ratings.

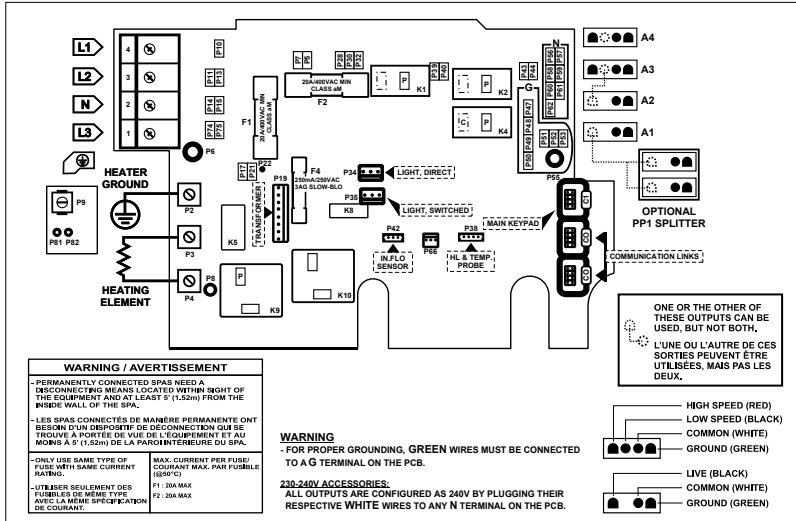

DIRECT (A4)		PUMP 1 (A3)		PUMP 2 / BLOWER / 03 / ABG* (A1)		PUMP 2 / BLOWER / 03 / CP / ABG* (A2)	
Voltage	230 V	Voltage	230 V	Voltage	230 V	Voltage	230 V
Green / ground	P47	Green / ground	P49	Green / ground	P52	Green / ground	P51
Black / line	P32	Black / low speed	K2-P	Black / line	K4-P	Black / low speed	K2-P
White / common	P56	Red / high-speed	K1-P	White / common	P62	White / common	P60
		White / common	P59				

CIRC. PUMP** (A1)		LIGHT (12 V AC, 1A MAX.)	
Voltage	230 V	Voltage	
Green / ground	P52	Always on	P34
Black / line	K4-P	Relay	P35
White / common	P62		

* ABG: Auxiliary Bubble Generator
 ** Ozonator and circ pump can be combined on the same output via the optional slitter PP1.
 This table shows typical connections. OEMs may have a different connection scheme.

WIRING DIAGRAM - W3000 & W5000

ELECTRICAL WIRING

ELECTRICAL WIRING: W3000 & W5000 (EUROPEAN)

Refer to wiring diagram in the enclosure box lid for more information.

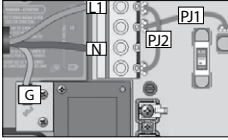

1-phase

L1 current returns through neutral

Connect P1 between P7 and P13. Connect P2 between P10 and P74.

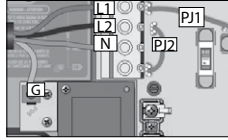

2-phase

with single neutral L1+L2 currents return through neutral

Connect P1 between P7 and P10. Connect P2 between P13 and P74.

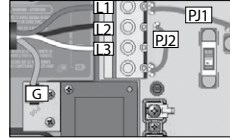

2-phase used from 3-phase Delta – no neutral

Use 2-phase setting

L1+L2 currents return through L3

Connect P1 between P7 and P10. Connect P2 between P13 and P74.

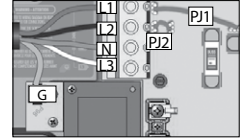

3-phase

with single neutral

L1, L2+L3 currents return through neutral

Connect P1 between P7 and P10. Connect P2 between P11 and P13.

W3000 & W5000 230 V OR 230/400 V

Correct wiring of the electrical service box, RCD, and pack terminal block is essential! Call an electrician if necessary.



WARNING!

W3000 & W5000 models must always be connected to a circuit protected by a Residual-Current Device (RCD) having a rated operating residual-current not exceeding 30 mA.

WIRING DIAGRAM - W8000



WIRING DIAGRAM - W8000

CONNECTIONS

CONNECTING HIGH VOLTAGE ACCESSORIES: EUROPEAN MODEL in.yt

For the connection to the 0.250 inch terminals, the high voltage accessories must be provided with female quick connect terminals, straight and non-insulated for all types of connections, including the ground. Only 230 V accessories may be connected to the corresponding terminals of the printed circuit of the in.yt. Refer to the following tables for correct connections. Note that all female terminals must be correctly and completely seated on the printed circuit terminals for proper current ratings.

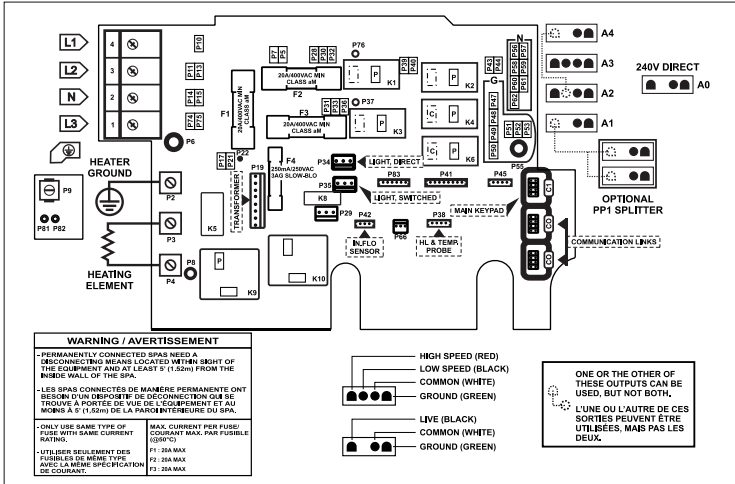

DIRECT OUTPUT 1 (A4)

Voltage	230 V
Green / ground	P48
Black / line	P32
White / common	P57

DIRECT OUTPUT 2 (C1)

Voltage	230 V
Green / ground	P92
Black / line	P132
White / common	P86

AUXILIARY (B1) (IN.YT-12-CE ONLY)

Voltage	230 V
Green / ground	P118
Black / line	K26-P
White / common	P124

PUMP 1 (A3)

Voltage	230 V
Green / ground	P49
Black / low speed	K2-P
Red / high-speed	K1-P
White / common	P58

PUMP 2 (A2)

Voltage	230 V
Green / ground	P50
Black / low speed	K23-P
Red / high-speed	K3-P
White / common	P88

PUMP 3 (C3)

Voltage	230 V
Green / ground	P94
Black / low speed	K22-P
Red / high speed	K21-P
White / common	P88

PUMP 4 (B2) (IN.YT-CE ONLY)

Voltage	230 V
Green / ground	P117
Black / low speed	K26-P
Red / high speed	K27-P
White / common	P123

PUMP 5 (B3) (IN.YT-12-CE ONLY)

Voltage	230 V
Green / ground	P115
Black / line	K24-P
White / common	P121

BLOWER (B4) (IN.YT-12-CE ONLY)

Voltage	230 V
Green / ground	P114
Black / line	K25-P
White / common	P120

CIRCULATION PUMP (C2) (IN.YT-12-CE)

Voltage	230 V
Green / ground	P93
Black / line	K23-P
White / common	P87

OZONATOR (A1)

Voltage	230 V
Green / ground	P51
Black / line	K4-P
White / common	P60

CIRCULATION PUMP (C2) (IN.YT-7-CE)

Voltage	230 V
Green / ground	P93
Black / line	K22-P
White / common	P87

LIGHT (12 V AC, 1A MAX.)

Voltage	230 V
Always on	P34
Relay	P35

WIRING DIAGRAM - W8000

ELECTRICAL WIRING

ELECTRICAL WIRING: W8000 (EUROPEAN)

Refer to wiring diagram in the enclosure box lid for more information.

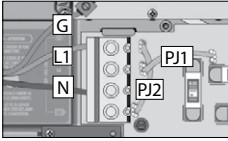

1-phase
L1 current returns through neutral

Connect PJ1 between P7 and P13. Connect PJ2 between P10 and P74.

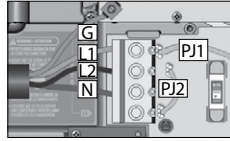

2-phase
with single neutral L1+L2
currents return through neutral

Connect PJ1 between P7 and P10. Connect PJ2 between P13 and P74.

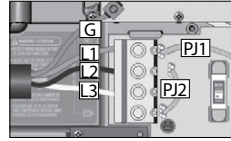

2-phase used from 3-phase
Delta – no neutral

Use 2-phase setting

L1+L2 currents return through L3

Connect PJ1 between P7 and P10. Connect PJ2 between P13 and P74.

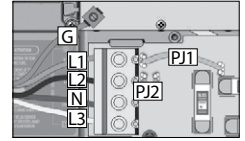

3-phase with single neutral
L1, L2+L3 currents return through neutral

Connect PJ1 between P7 and P10. Connect PJ2 between P11 and P13.

W8000 230 V OR 230/400 V

Correct wiring of the electrical service box, RCD, and pack terminal block is essential!
Call an electrician if necessary.



WARNING!

W8000 models must always be connected to a circuit protected by a Residual-Current Device (RCD) having a rated operating residual-current not exceeding 30 mA.

BREAKER SETTING

POWER UP AND BREAKER SETTING

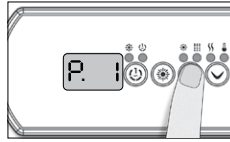
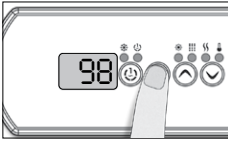

It is important to specify the current rating of the GFCI/RCD used to ensure a safe and efficient current management (and reduce nuisance GFCI/RCD trippings).

Press and hold the Prog. button until you access the breaker setting menu. (the programming menu will appear first). If your control system is equipped with the phase configuration menu, it will appear before the breaker setting menu.

Note: if the keypad does not have the Prog. Key, use the Light key.

For color display keypad go in setting menu.

The tables below indicate the typical value of b for different GFCI/RCD ratings.

Choose the one that corresponds to your breaker.

Note: Every OEM has its own pre-established configurations.

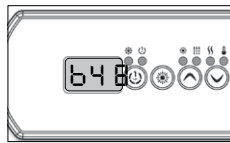

W2000

GFCI/RCD	b
50A	40A*
40A	32A
30A	24A
20A	16A
16A	12.8A
15A	12A

W3000, W5000 & W8000

GFCI/RCD	b
60A	48A
50A	40A
40A	32A
30A	24A
20A	16A

W2000

Selecting number of phases

UL Menu not available

CE Menu not available

W3000, W5000 & W8000

Selecting number of phases

CE 1, 2 or 3

CE Swim* 1, 2 or 3

*** For more information see the Swim spa system Techbook.**



The values displayed by the system correspond to 80% of the maximum amperage capacity of the GFCI.

Use the Up or Down keys to choose the desired value.

The value can typically be modified from 10 to 48 A.

Press on the Prog. key to set the breaker rating.

* Only available on in.yj-3.

BREAKER SETTING

POWER UP AND BREAKER SETTING

IMPORTANT Please read the following before starting the device.

Verify that all accessories are linked to the ground lug and connected to the to the control system.

A minimum flow of 68 LPM (18 GPM) is required. Make sure that all valves are open in the spa plumbing and that the water flow is sufficient between the main pump and the water heater.

Turn on the breaker.

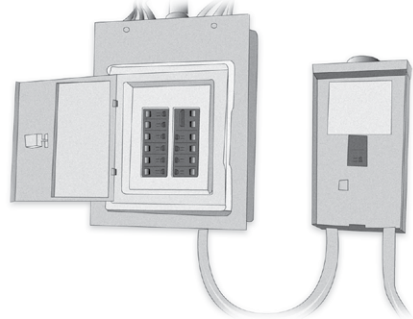

IN.FLO DRY-FIRE PROTECTION

At start up, the in.flo's detector verifies the water flow according to the following sequence:

The Pump 1 or the circulation pump runs for a period of 2 to 5 minutes.

The display will show "--" during the flow verification. After this time, the system confirms if flow is adequate or not.

If the flow is sufficient, the temperature of the water is displayed on the keypad screen. When the water has reached the consigned temperature plus 0.45°C (0.8°F), the water heater turns off.

DISPLAY SEQUENCE AT START UP (EVERY PARAMETER IS DISPLAYED FOR 2 SECONDS)



Lamp test

All segments and LEDs light up.



Software number

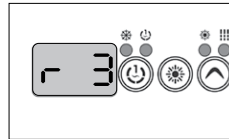

Software revision

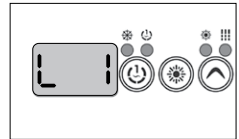

Low-level selected

Low-level selected from the low-level menu.

FREQUENTLY ASKED QUESTIONS

QUESTIONS CONCERNING CLEANING, WATER TREATMENT, AND MAINTENANCE

What should I do if the filter of the spa is polluted?

Clean the filter every week or two weeks with a jet of water. Periodically, depending on usage, soak the filter in water mixed with an antialgae agent for 1-2 hours, then rinse it.

Should I shower before using the spa?

Yes, thoroughly.

Should the side cover of the spa be treated?

The side cover is made from weather resistant plastic. It does not require treatment or maintenance (except if it is a cedar cover).

How often should the water be changed if my spa has the in.clear water maintenance system? Does it maintain water quality?

With the cutting-edge automated brominating in.clear system water only has to be changed approximately once every 6 months. This can be even longer if the spa is not used daily. Adding water and Trublu (sodium bromide) may be necessary if the water level decreases because of splashing or evaporation. Optional UV-C antibacterial agents, disinfectant, and a sterilization system are available for our spas. These guarantee fresh and pure water using 30-50% fewer chemicals.

What kind of water treatment do you recommend in case of communal use?

In case of communal use we recommend the optional sand filtration device that comes in place of the standard antibacterial filter. In case of heavy usage we recommend the automated monitoring-, regulating-, and chemical dispenser device.

I cannot stop the heavy foaming. Before using the spa we shower without using soap and I use the necessary chemicals. Did I use too little?

As described in the user guide of the products, apply 1-2 cups of antifoaming agent to the spa water. Wait for the chemical to thoroughly mix with the water. Repeat if necessary. If the problem is still present, check and readjust the pH value. If foaming still occurs, disinfect the spa with an antialgae chemical containing free active chlorine, then drain, clean, rinse, and refill the spa.

PREPARATION OF THE INSTALLATION SITE

What are the most important concerns when selecting the installation site?

The installation site should be prepared in accordance with the installation guide by a professional. The devices can only be installed and set up at appropriate installation sites. Make sure there is an appropriate cable length, electric supply, a 30mA protective relay, and with certain products a floor drain.

Is a floor drain necessary for an indoor spa?

Building a floor drain is mandatory!

TECHNICAL DATE OF THE PRODUCT, USAGE

What type of water circulation engine is used for massage spas?

Our massage spas are equipped with Laing low power (110W) energy saving, silent circulating motor pumps.

What is the maximal temperature that does not damage the spa?

The water temperature can be adjusted to between 26 and 40 degrees Celsius.

What is the recommended optimal water temperature?

32-38 degrees Celsius. If young children are using the spa, lower temperature is recommended. Always check the water temperature before the child steps into the spa and make sure that the temperature is suitable for the child.

Can the system freeze? Is there a sensor that starts emergency heating in case of freezing?

In the winter the unused spa should be winterized. After draining the spa we will defrost the system as necessary, meaning that we will remove the water retained by the engine and the pipes. For details and pricing please call our customer service. If the spa remains in use during the winter, the engines start if there is a danger of freezing and heat the water to 8°C.

Can the system be programmed to start heating at certain time?

There is no way of setting a time and date for automatic heating. Because of concerns of energy efficiency heating the water to greater temperatures is not recommended in case of multiple weekly usage.

The jet of the spa shuts down automatically after 15 minutes of operation. Can I restart it immediately, or do I have to wait? Can I restart it as many times as I want without a break? How does this affect the jets?

The hydromassage system shuts down every 15 minutes for security reasons - to avoid possible muscle soreness. It can be restarted for any amount of times and without a break.

Is this the same for the bubble massage function?

Yes, it is the same for the bubble massage function.

FREQUENTLY ASKED QUESTIONS

When we do not use the spa often, mostly in the winter (around 3 times a week), which is the most energy efficient setting, taking into account the energy necessary for reheating? We only use it a couple of times a week, 37 degrees Celsius is our favourite temperature. Should it be in Sleep or Economy mode? Should I switch to the Standard setting only when heating the spa? Or should it always stay on Standard?

If you only use it 2-3 times a week, the most efficient way is to keep the water at operational temperature (38 degrees Celsius). Thanks to the excellent insulation and the thermo cover this setting requires less energy than letting the water cool down and reheating it before usage. The heating system automatically switches on in case the water temperature drops more than half a degree Celsius. In the summer the Economy setting is recommended as the external temperature is usually high. Only use the Sleep setting if you are not using the spa for a longer period of time (3-4 weeks).

Does the spa switch back to the last used setting if there is a power outage?

When connecting the spa to the power supply it switches to charging mode. Push the "Temp" button to set it to the Standard setting and it will display the water temperature. The spa will switch back to the last used setting after a power outage.

Can the filtration cycle only be programmed to 1-8 hour periods? Is there something like a 3-hour period? What is ideal and what is adequate?

The filtration cycle can be set to 1-8 hour or continuous settings. If you have a spa equipped with the in.clear automatic water management system, a daily 8-hour circulation period is recommended to produce necessary amounts of bromine. The 8-hour (2x4 hour) setting is ideal.

Can the operating device for our spa be placed in an external location where only the staff can access it?

The operating device can only be placed 5 meters cable length away from the spa.

What is the service life of the UV-C lamp?

If the filtration cycle is set to the continuous (0-24) setting, then the service life of the UV-C lamp is 8000-9000 hours. With continuous setting the most effective water disinfectant system can reduce the necessary amount of chemicals by 30-50% depending on usage.

IN.CLEAR

Why is the water turbulent/oily?

If the water is turbulent or oily after heavy usage, perform a refill and wait 24 hours until conditions are suitable for usage. If the problem persists, contact your service provider to perform the necessary water equilibration.

Does sodium-bromide vaporize?

No. Sodium-bromide will only leave the spa in case of splashing, leaking, or draining.

What should I use to clean my spa?

Only nonfoaming nonacetic cleaning products available at professional dealerships.

If the in.clear bromine generator is switched off, is the spa still being disinfected by sodium bromide?

No. The in.clear system does not disinfect while switched off. However, if there is a level of bromine left over in the water, it will continue the disinfecting process. The In.clear system can be switched off for certain periods of time and the spa will remain nice and clean. Sodium bromide becomes bromine when it passes through the electrodes of the in.clear system, while the pump connected to the in.clear system is operational.

